

# EARTH FAULT RELAY RX232



## FEATURES

- Built-in NFC for reading and setting parameters through mobile app
- Real-time monitoring of system condition
- Built-in self test and soft recovery watchdog
- Internal relay failure (IRF) alarm for system abnormalities
- Time-stamp event record of power failure and setting changes up to 120 events.
- Time-stamp record of up to 30 faults and 30 pickups
- Two-stage setting for earth fault
- 5 selectable IDMT and definite times
- Circuit breaker failure protection
- Selectable fundamental or true RMS measurement
- Selectable 50 or 60 Hz frequency
- Programmable output contacts
- Complies with IEC 60255 standard
- ANSI code: 50G, 50N, 51N, 50BF

## SPECIFICATIONS

### RATING

Rate Current In	: 5A
Frequency	: 50 or 60Hz
Burden	: <0.3VA at In
Thermal Withstand	: 4 x In Continuous

### AUXILIARY SUPPLY

Supply Voltage	: 198 ~ 265VAC
Supply Frequency	: 50 or 60Hz
VA Rating	: 3VA max

### ACCURACY

Protection Thresholds	: ±3% or ±20mA
Time Delay	: ±3% or ±40ms

### NFC COMMUNICATION

Operation System	: Android OS and IOS
App Name	: MikroNFC

### SETTING RANGES

#### Earth-fault Setting

lo>	: 0.1A-10.0A(2% -200%), *(Variable steps 1)
ktlo>	: 0.01 -1.00, *(Variable steps 2)
tlo>	: 0.03 -100s, *(Variable steps 2)
lo>Delay Type	: DT, NI3/10, NI1.3/10, VI, LI, EI
lo>>	: OFF/0.1 -50A (10% -1000%), *(Variable steps 1)
tlo>>	: 0.03 -100s, *(Variable steps 2)

### OUTPUT CONTACTS

Rated Voltage	: 250VAC
Continuous Carry	: 5A (Cosφ=1.0)
Expected Electrical Life	: 10 <sup>5</sup> operations
Expected Mechanical Life	: 5 x 10 <sup>6</sup> operations
No of Output Contact	: 2

### ENVIRONMENTAL CONDITIONS

Operating Temperature	: -10°C to 55°C
Humidity	: 5% to 95%, non-condensing

### MECHANICAL

Mounting	: Panel mounting
Dimension (mm)	: 96(w) x 96(h) x 90(d)
Enclosure protection	: IP54 at the panel IP20 at the body
Approximate weight	: 0.65kg



\*Variable Steps 1: step 0.05 (<10), step 0.1 (<100)

\*Variable Steps 2: step 0.01 (<1), step 0.1 (<10), step 0.5 (<100)

## IDMT CURVE

EARTH FAULT RELAY RX232

**NORMAL INVERSE 3/10**

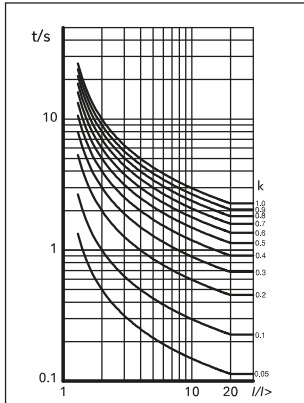

**NORMAL INVERSE 1.3/10**

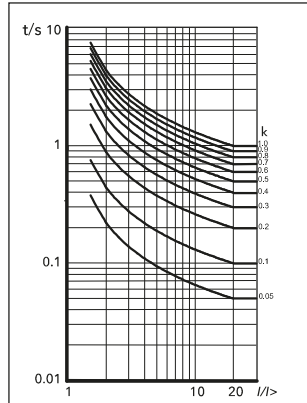

**VERY INVERSE**

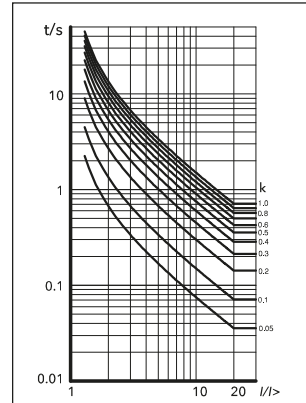

**LONG-TIME INVERSE**

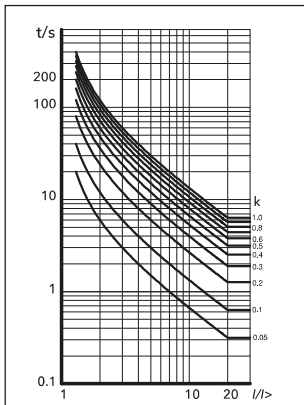

**EXTREMELY INVERSE**

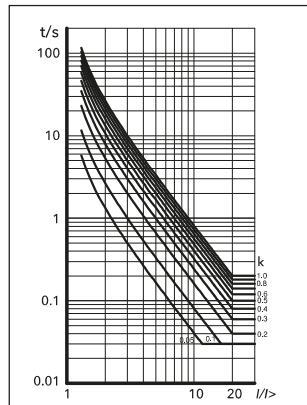

## TYPICAL APPLICATION DIAGRAM

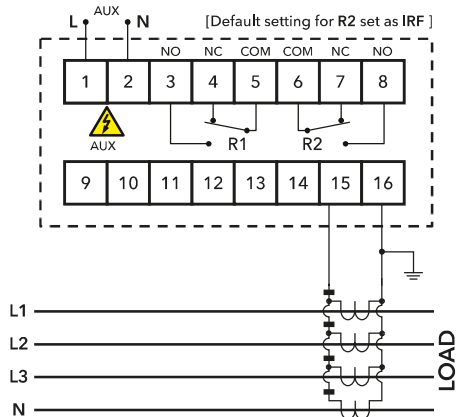

## CASE DIMENSION

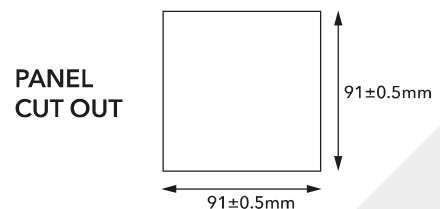
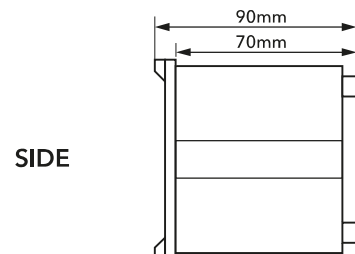
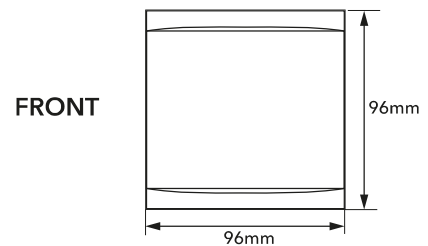

## ORDERING INFORMATION

MODEL	DESCRIPTION
RX232-230A	Auxiliary Voltage 198~265 VAC, frequency 50 or 60Hz