



Metasol

Meta Solution

Low voltage circuit breakers



Leader in Electrics & Automation

***Upgraded for the global
best worth!***

Metasol

Molded case circuit breaker / Earth leakage circuit breaker

Marking and configuration	16
External configuration	18
Quick selection table (Molded Case Circuit Breakers)	20
Quick selection table (Earth Leakage Circuit Breakers)	24
Ratings	28
Accessories	60
Type numbering system	71
Characteristics curves	72
Dimensions	76
Technical Information	88
Catalogue numbers	104



Metasol
ABS 203c

250AF		3P
Ue	~	Ics=Icu 8kA
690V	~	26kA
480/500V	~	37kA
415/460V	~	42kA
380V	~	85kA
220/240V	~	20kA
500V	~	20kA
250V	~	20kA
Ics = 100%Icu		
50/60Hz		
Cat. A		



Metasol

Meta solution



Metasol ABS 203c		
250AF		
Ue		3P
690V		
480/500V	~	Ics=Icu
415/460V	~	8kA
380V	~	26kA
220/240V	~	37kA
500V	~	42kA
250V	~	85kA
Ics = 100%Icu	---	20kA
50/60Hz	---	20kA
Cat. A		

CE IEC60947-2
LS Industrial Systems
MADE IN KOREA

MCCB = ELCB

Metasol

Molded case circuit breaker / Earth leakage circuit breaker

Upgrade of Meta-MEC series

... **Metasol** Low voltage circuit breaker

- $I_{cs} = 100\% \times I_{cu}$
- $U_i = 750V$
- $U_{imp} = 8kV$



• *Compatible and differentiated design*

- Compatible with the Meta-MEC
- Outlook differentiated design

• *Same External dimension with MCCB and ELCB*

• *Upgrade the coordination*

- Upgrade the coordination with Susol / Meta-MEC mass capacity

• *Upgrade breaking capacity*

- N100AF : 10 \Rightarrow 18kA
- S125AF : 25 \Rightarrow 37kA
- S250AF : 25 \Rightarrow 37kA
- H250AF : 35 \Rightarrow 50kA
- N400AF : 25 \Rightarrow 37kA
- S400AF : 35 \Rightarrow 50kA
- S800AF : 50 \Rightarrow 65kA

• *$I_{cs} = 100\% I_{cu}$*

Metasol MCCB/ELCB



Ics = 100% Icu

Metasol MCCB

Upgrade breaking capacity

460V

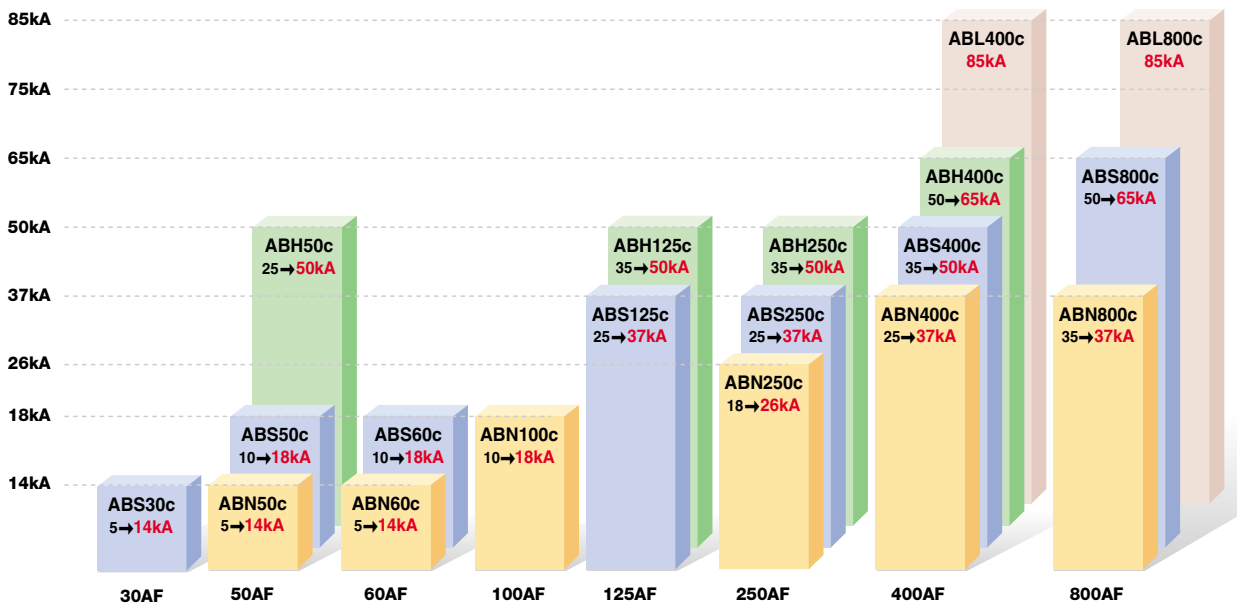

Short-circuit breaking capacity

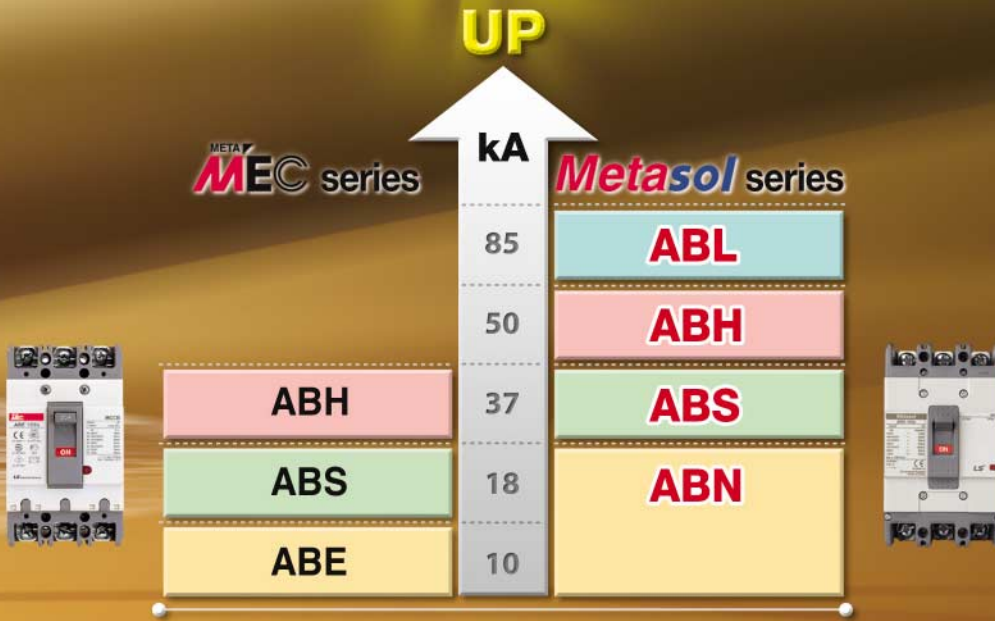

Upgrade breaking capacity

- N100AF :
10 → **18kA**
- S125AF :
25 → **37kA**
- S250AF :
25 → **37kA**
- H250AF :
35 → **50kA**
- N400AF :
25 → **37kA**
- S400AF :
35 → **50kA**
- S630AF :
50 → **65kA**
- S800AF :
50 → **65kA**

Metasol ELCB

Upgrade breaking capacity

460V

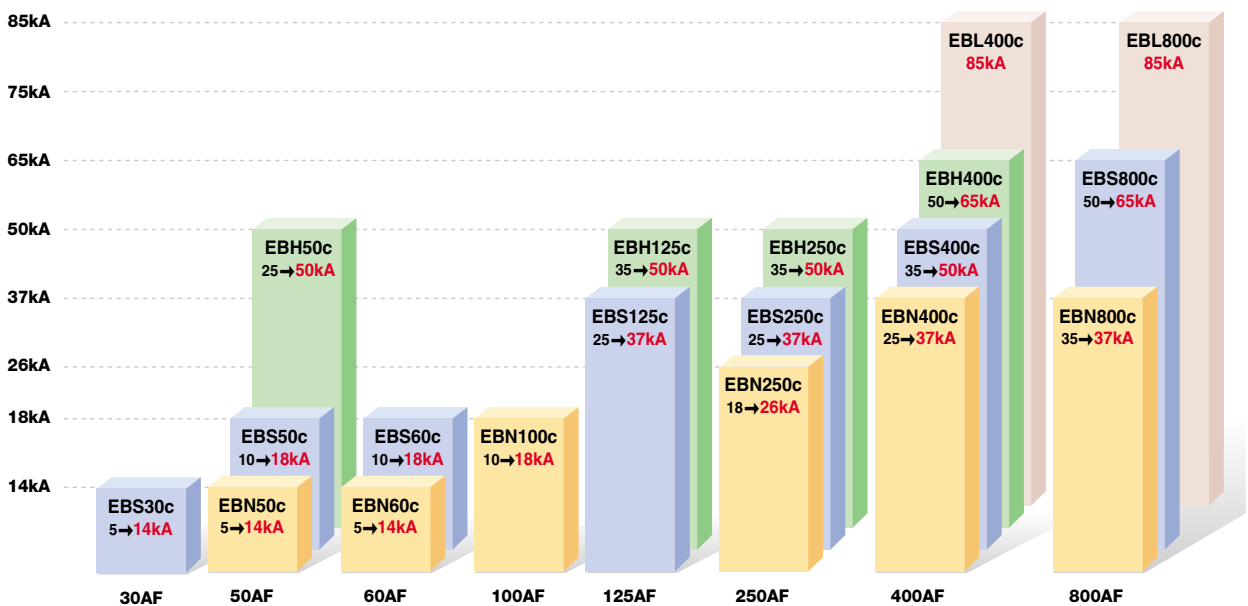

Metasol MCCB/ELCB Compatible and Standard

- 100% compatible with Meta-MEC Series.
- Standardized dimension (Depth, Cutout) when the panel is made.

MCCB (Molded Case Circuit Breaker)



105 × 165 × 60mm



90 × 155 × 60mm



75 × 130 × 60mm

Metasol MCCB

AF Type	30AF	50AF	60AF	100AF	125AF	250AF	400AF	800AF
ABN		ABN50c 14kA	ABN60c 14kA	ABN100c 18kA		ABN250c 26kA	ABN400c 37kA	ABN800c 37kA
ABS	ABS30c 14kA	ABS50c 18kA	ABS60c 18kA		ABS125c 37kA	ABS250c 37kA	ABS400c 50kA	ABS800c 65kA
ABH		ABH50c 50kA			ABH125c 50kA	ABH250c 50kA	ABH400c 65kA	
ABL							ABL400c 85kA	ABL800c 85kA

Note) Dimension is for 3 pole and breaking capacity is for AC460V.

- Same external dimension with MCCB and ELCB.

ELCB (Earth leakage circuit breaker)



Metasol ELCB

AF Type	30AF	50AF	60AF	100AF	125AF	250AF	400AF	800AF
EBN		EBN50c 14kA	EBN60c 14kA	EBN100c 18kA		EBN250c 26kA	EBN400c 37kA	EBN800c 37kA
EBS	EBS30c 14kA	EBS50c 18kA	EBS60c 18kA		EBS125c 37kA	EBS250c 37kA	EBS400c 50kA	EBS800c 65kA
EBH		EBH50c 50kA			EBH125c 50kA	EBH250c 50kA	EBH400c 65kA	
EBL							EBL400c 85kA	EBL800c 85kA

Note) Dimension is for 3 pole and breaking capacity is for AC460V.

Metasol MCCB/ELCB System overview

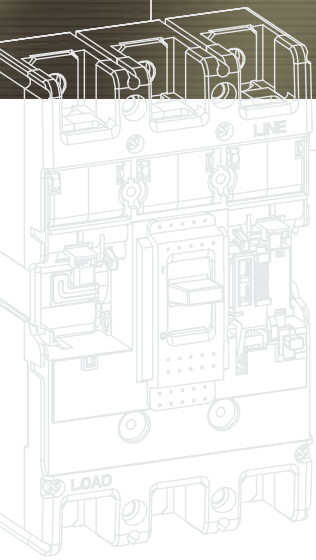

■ Various installable Accessories

- Wider range of installable accessories compared to Meta MEC series.
- Composed of User Friendly Method.

System overview

- 1 Breaker
- 2 Internal auxiliaries
- 3 Plug-in kit
- 4 Rotary handle (direct)
- 5 Rotary handle (direct, key lock)
- 6 Rotary handle (extended)
- 7 Motor operator
- 8 Rear terminal
- 9 Terminal cover (Short, Long)
- 10 Insulation barrier

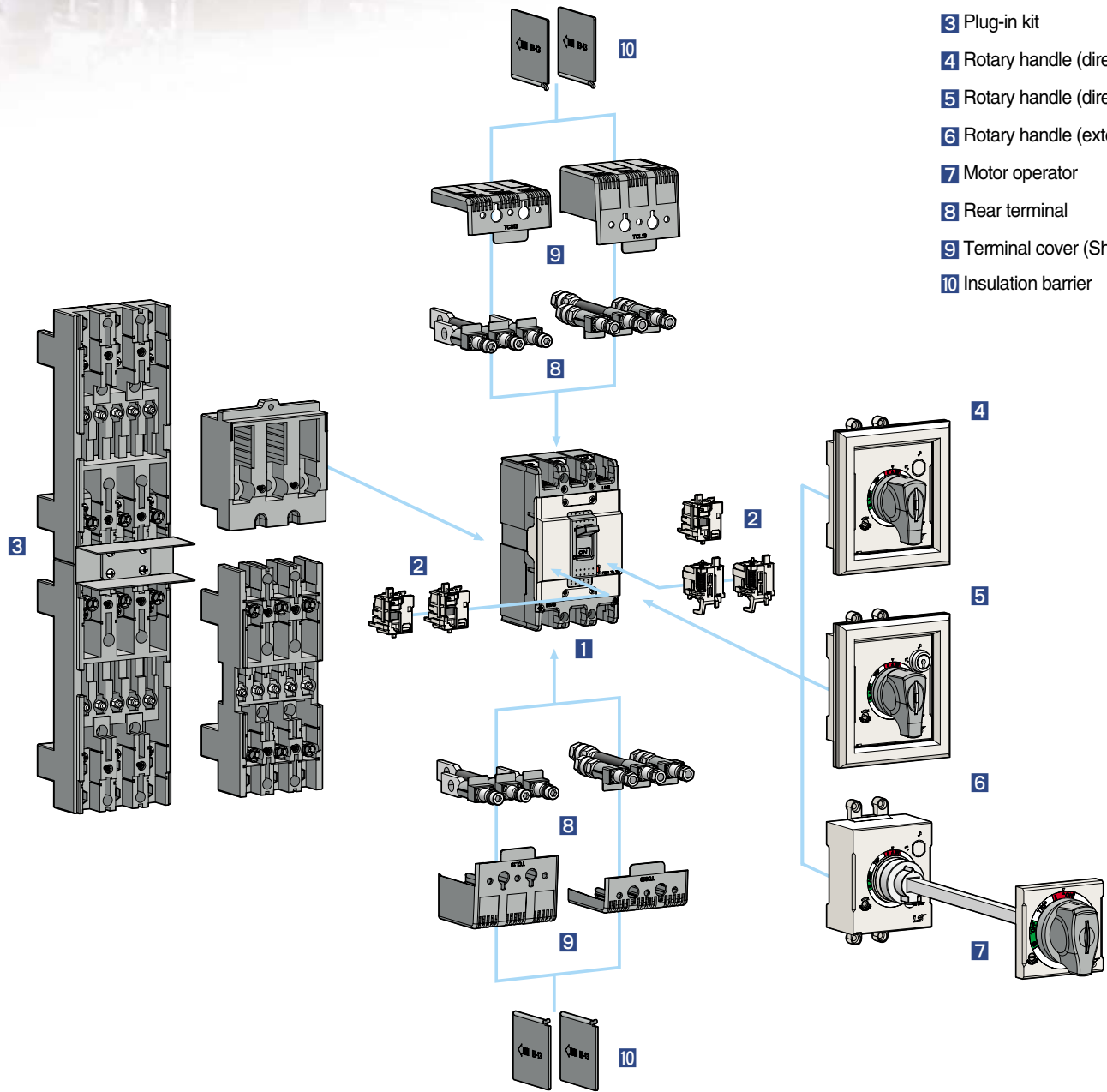

Metasol MCCB/ELCB Internal accessories

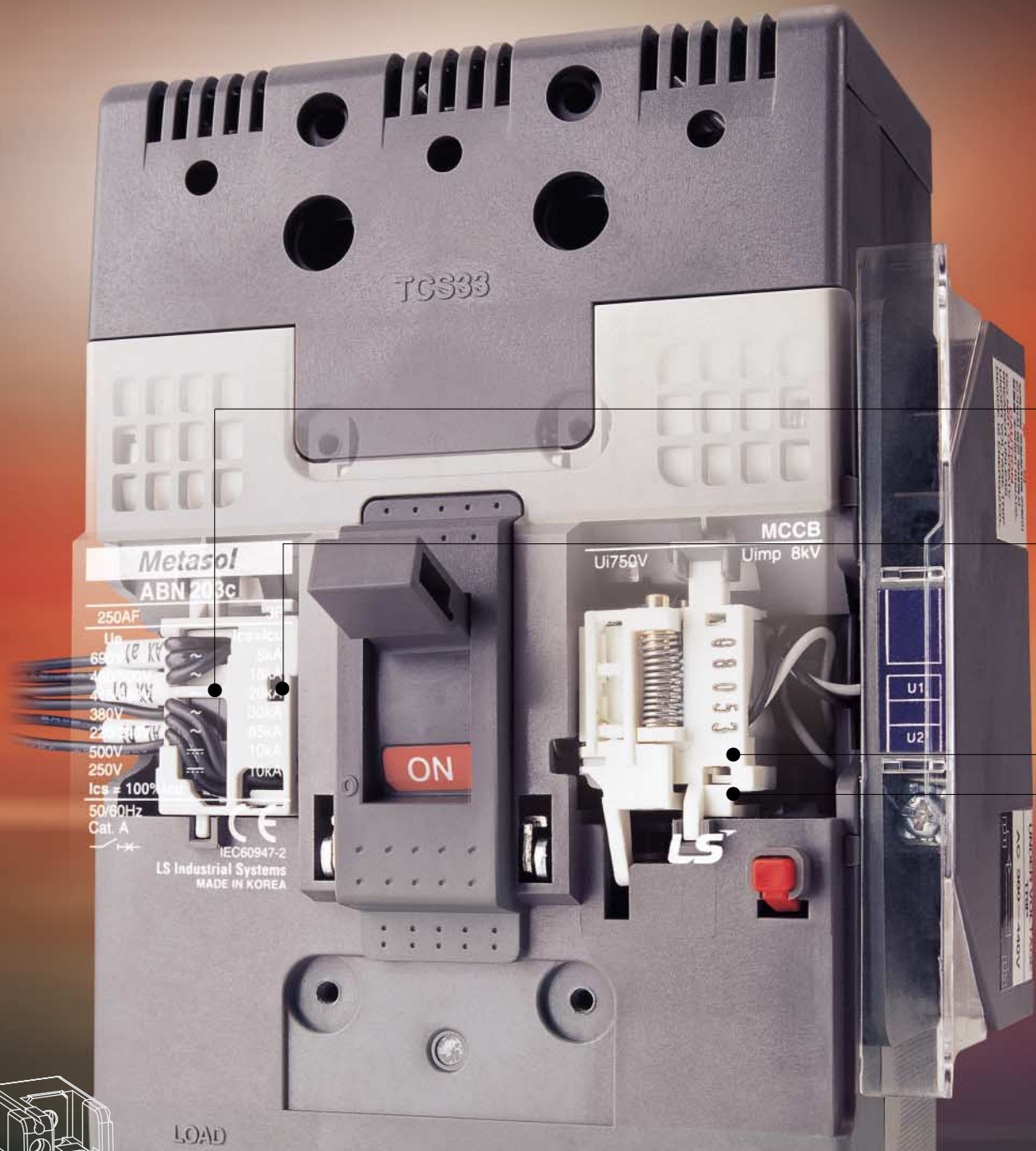

Internal Accessories

Internal Accessories can be commonly used in all Metasol MCCB and ELCB
(Notice: Exception of SHT, UVT in ELCB)

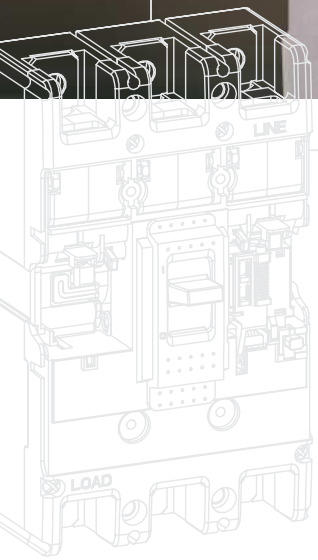

Common use to all Metasol MCCBs and ELCBs



Alarm Switch (AL)

Alarm switches offer provisions for immediate audio or visual indication of a tripped breaker due to overload, short-circuit, operation of shunt trip, or undervoltage trip conditions, operation of push button.

They are particularly useful in automated plants where operators must be signaled about changes in the electrical distribution system. This switch features a closed contact when the circuit breaker is tripped automatically. In other words, this switch does not function when the breaker is operated manually. Its contact is open when the circuit breaker is reset.



Auxiliary Switch (AX)

Auxiliary switch is for applications requiring remote “ON” and “OFF” indication. Each switch contains two contacts having a common connection. One is open and the other closed when the circuit breaker is open, and vice-versa.



Undervoltage trip (UVT)

The undervoltage trip automatically opens a circuit breaker when voltage drops to a value ranging between 35% to 70% of the line voltage. The operation is instantaneous, and the circuit breaker cannot be reclosed until the voltage returns to 85% of line voltage.

Continuously energized, the undervoltage trip must be operating before the circuit breaker can be closed.



Shunt Trip (SHT)

The shunt trip opens the mechanism in response to an externally applied voltage signal. LS shunt trips include coil clearing contacts that automatically clear the signal circuit when the mechanism has tripped. contact with live parts and thereby guarantee protection against direct contacts.

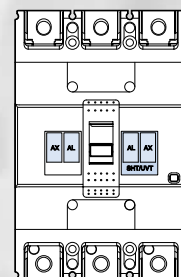
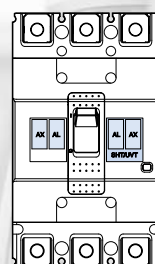
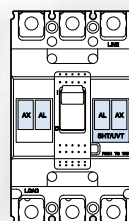

Metasol MCCB/ELCB External accessories

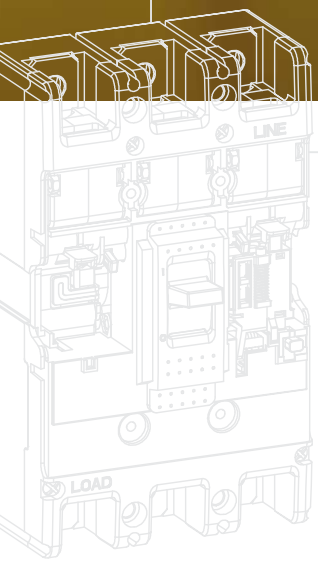

■ External Accessories

Designed for various mount and user safety.

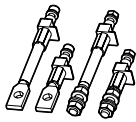

Front and rear connection

Several kinds of terminals can be equipped with ELCBs as well as MCCBs.

- Terminals for front connection
- Rear connection terminals

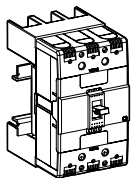

Plug-in base

It makes to extract and/or rapidly replace the circuit breaker without having to touch connections.(Easy replacement and maintenance)

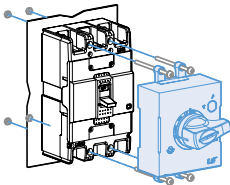

Direct & Extended Rotary Handle

There are two types of rotary handles.

- Direct rotary handle(with or w/o key lock device)
- Extended rotary handle

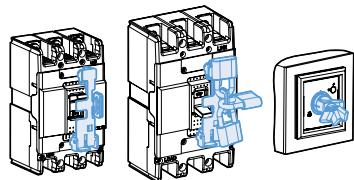

Locking device

- Fixed padlock
- Removable padlock
- Key lock device on direct handle



Insulation barrier

These allow the insulation characteristics between the phases at the connections to be increased.

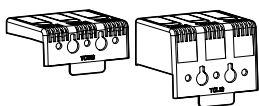

Insulation terminal cover

The terminal covers are applied to the circuit-breaker to prevent accidental contact with live parts and thereby guarantee protection against direct contacts.

Marking and configuration

MCCB

MCCB model

- ABN: Economic type
- ABS: Standard type
- ABH: High capacity type

Standardized characteristics

- Ui: Rated insulation voltage
- Uimp: Impulse withstand voltage
- Ue: Rated operational voltage
- Icu: Ultimate breaking capacity
- Ics: Service breaking capacity



Rated frequency

Utilization category

Manufacturer

Standard

Symbol indicating suitability for isolation as defined by IEC 947-2

MCCB

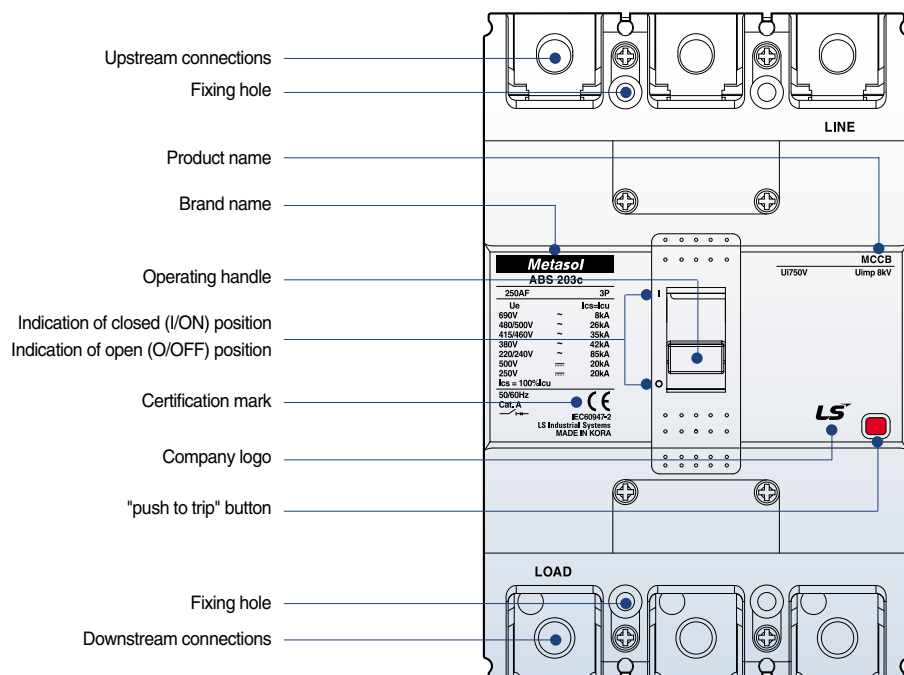

ELCB



ELCB model

- EBN: Economic type
- EBS: Standard type
- EBH: High capacity type

Rated frequency

Standard

Manufacturer

Utilization category

Symbol indicating suitability for isolation as defined by IEC 947-2

ELCB

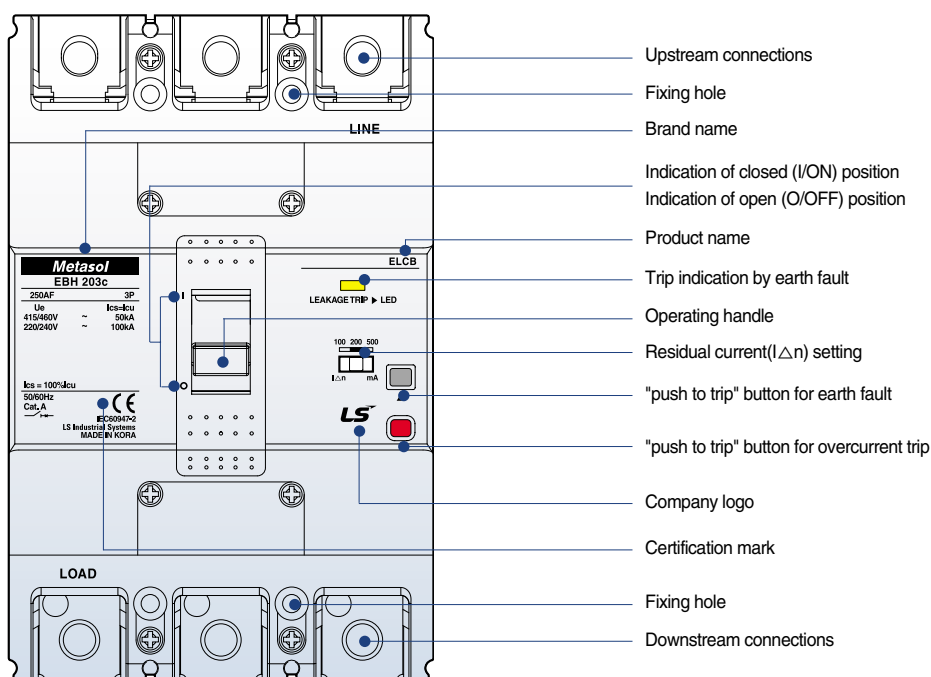

External configuration

MCCB

① Handle

- Function of indications
 - "ON" "OFF" "TRIP"
- Resetting

When the handle indicates "tripped" position it must first be reset by moving the handle to the "OFF" position and then closing is possible
- Trip-Free even if the handle is held at "ON", the breaker will trip if an over current flows
- Suitable for Verification of the main contact position under abnormal conditions because the handle doesn't indicate open position

② Arc-Extinguishing unit

- LS patent technique PASQ
Arc-Extinguishing unit
PASQ : Puffer Assisted Self-Quenching
- Reduction of arc voltage for a short time

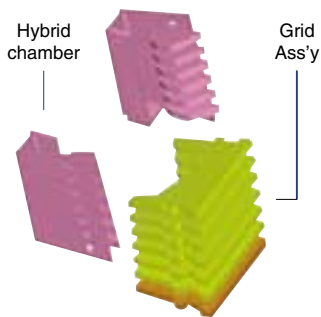

③ Trip button (push to trip)

- Enables tripping mechanically from outside, for confirming the operation of the accessory switches and the manual resetting function.

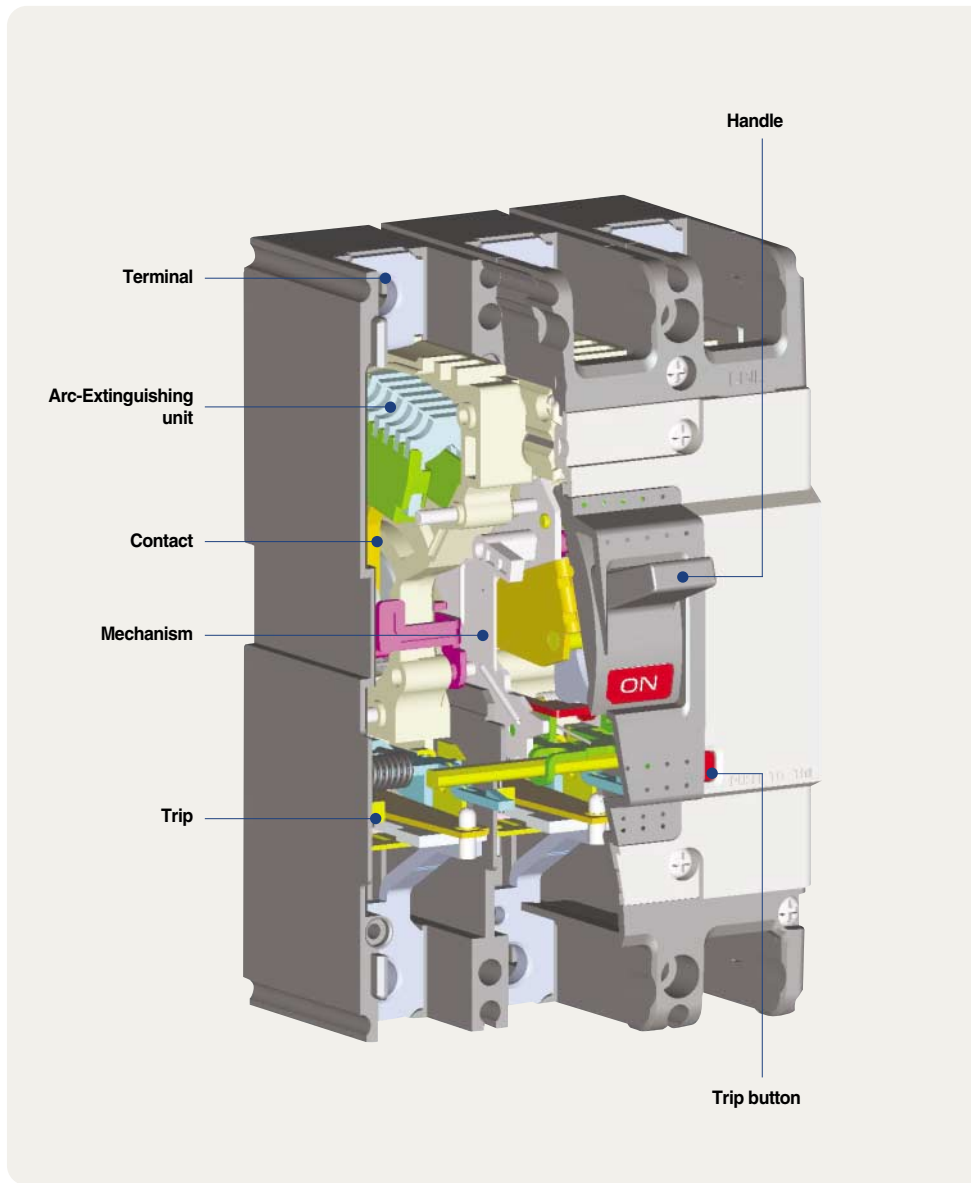

A Application of PASQ Arc Extinguishing

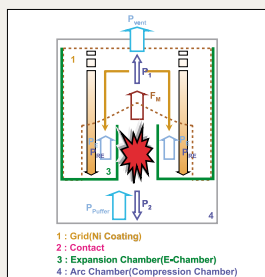

- The reduction of breaking time by applying PASQ arc extinguishing for inhibition of arc voltage for a short time.

A Application of Current limiting structure

- Current limiting repulsion structure (U fixed structure)
- Toggle structure
 - When the operating unit repulses by short circuit current, repulsion structure at bigger angle.



ELCB

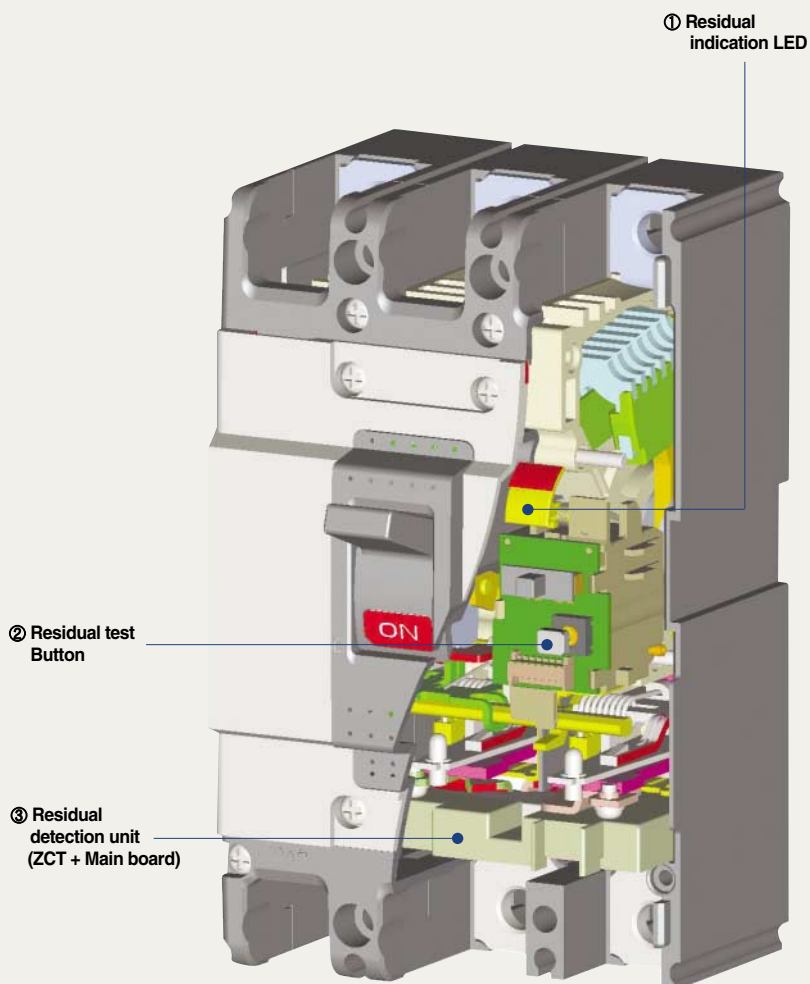

① Residual indication LED

- Normal situation is yellow , trio situation is red

② Residual test Button

- Special design for Upgrade to prohibit resistance accident

③ Residual detection unit (ZCT + Main board)

- For upgrade the design is selected the 3 phase input power method and in case of Voltage problem, it can break residual current safely.

Upgrade coil operation by special design



- Sliding structure application of Trip lever
- Trip special design by applying design Button method.
- Upgrade the testing unit

3 phase power supply method

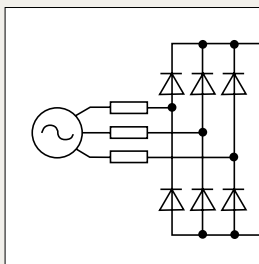

- In case of 1 phase loss residual operation upgrade
- New IEC standard

Quick selection table

Molded Case Circuit Breakers



MCCBs

AF	30AF	50AF			60AF		
Type	S-Type	N-Type	S-Type	H-Type	N-Type	S-Type	
Type and Pole	2-pole 3-pole 4-pole	ABS32c ABS33c ABS34c	ABN52c ABN53c ABN54c	ABS52c ABS53c ABS54c	ABH52c ABH53c ABH54c	ABN62c ABN63c ABN64c	ABS62c ABS63c ABS64c
Rated current, I _n	A	(3, 5, 10), 15, 20, 30	15, 20, 30, 40, 50		15, 20, 30, 40, 50		15, 20, 30, 40, 50, 60
Rated operational voltage, U _e	AC(V)	690	690	690	690	690	690
	DC(V)	500	500	500	500	500	500
Rated insulation voltage, U _i	V	750	750	750	750	750	750
Rated impulse withstand voltage, U _{imp}	kV	8	8	8	8	8	8

Rated short-circuit breaking capacity(I_{cu}) kA (Sym), KSC8321, IEC 60947-2

AC	690V	2.5	2.5	5	10	2.5	5
	480/500V	7.5	7.5	10	35	7.5	10
	415/460V	14 (10)	14	18	50	14	18
	380V	18 (14)	18	22	50	18	22
	220/250V	30 (25)	30	35	100	30	35
DC	500V(3P)	5	5	10	30	5	10
	250V(2P)	5	5	10	30	5	10
I _{cs} =% × I _{cu}		100	100	100	100	100	100
Dimensions (mm)	W × H × D	75 × 130 × 60mm (Fig. 1)	75 × 130 × 60mm (Fig. 1)		90 × 155 × 60mm (Fig. 2)	75 × 130 × 60mm (Fig. 1)	
More info.	Ratings	28 page	30 page	30 page	30 page	32 page	32 page
	Curves	72 page	72 page	72 page	73 page	72 page	72 page
	Drawings	76 page	76 page	76 page	77 page	76 page	76 page

Note) The short-circuit breaking capacities in () are applied to the rated current in (3, 5, 10A)

AF Type	30AF	50AF	60AF	100AF	125AF	250AF
ABN		ABN50c 14kA	ABN60c 14kA	ABN100c 18kA		ABN250c 26kA
ABS	ABS30c 14kA	ABS50c 18kA	ABS60c 18kA		ABS125c 37kA	ABS250c 37kA
ABH		ABH50c 50kA			ABH125c 50kA	ABH250c 50kA

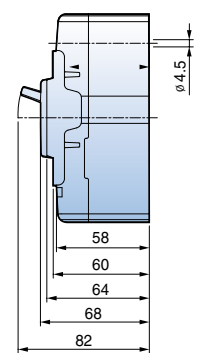
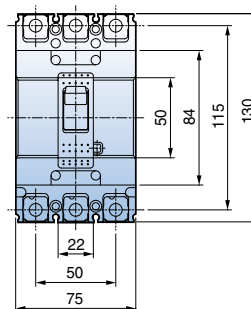

(Fig. 1)



	100AF			125AF			250AF		
	N-Type	S-Type	H-Type	N-Type	S-Type	H-Type	N-Type	S-Type	H-Type
	ABN102c	ABS102c	ABH102c	ABN202c	ABS202c	ABH202c	ABN203c	ABS203c	ABH203c
	ABN103c	ABS103c	ABH103c	ABN203c	ABS203c	ABH203c	ABN204c	ABS204c	ABH204c
	ABN104c	ABS104c	ABH104c	ABN204c	ABS204c	ABH204c			
	15, 20, 30, 40, 50, 60, 75, 100	15, 20, 30, 40, 50, 60, 75, 100, 125			100, 125, 150, 175, 200, 225, 250				
	690	690	690	690	690	690	690	690	690
	500	500	500	500	500	500	500	500	500
	750	750	750	750	750	750	750	750	750
	8	8	8	8	8	8	8	8	8
	5	8	10	8	8	10	8	8	10
	10	26	35	18	26	35	18	26	35
	18	37	50	26	37	50	26	37	50
	22	42	50	30	42	50	30	42	50
	35	85	100	65	85	100	65	85	100
	10	20	30	10	20	30	10	20	30
	10	20	30	10	20	30	10	20	30
	100	100	100	100	100	100	100	100	100
	75 × 130 × 60mm (Fig. 1)	90 × 155 × 60mm (Fig. 2)			105 × 165 × 60mm (Fig. 3)				
	34 page	36 page	36 page	38 page	38 page	38 page	38 page	38 page	38 page
	72 page	73 page	73 page	74 page	74 page	74 page	74 page	74 page	74 page
	76 page	77 page	77 page	78 page	78 page	78 page	78 page	78 page	78 page

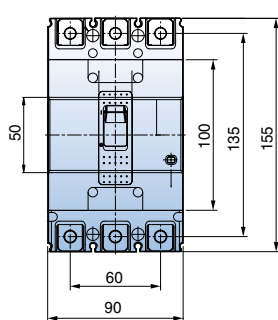

(Fig. 2)

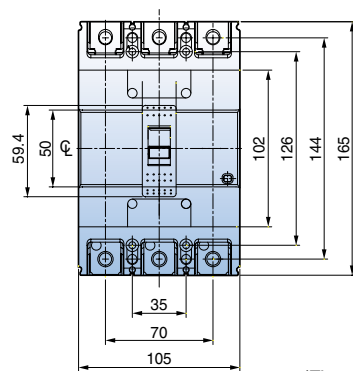
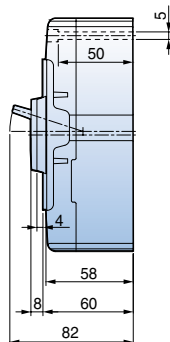

(Fig. 3)

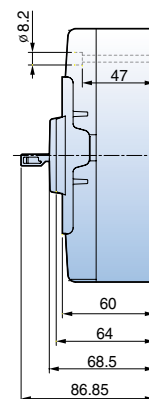

Quick selection table

Molded Case Circuit Breakers



MCCBs

AF		400AF			
Type		N-Type	S-Type	H-Type	L-Type
Type and Pole	2-pole	ABN402c	ABS402c	ABH402c	ABL402c
	3-pole	ABN403c	ABS403c	ABH403c	ABL403c
	4-pole	ABN404c	ABS404c	ABH404c	ABL404c
Rated current, I _n	A	250, 300, 350, 400			
Rated operational voltage, U _e	AC(V)	690	690	690	690
	DC(V)	500	500	500	500
Rated insulation voltage, U _i	V	750	750	750	750
Rated impulse withstand voltage, U _{imp}	kV	8	8	8	8
Rated short-circuit breaking capacity(I_{cu}) kA (Sym), KSC8321, IEC 60947-2					
AC	690V	5	8	10	14
	480/500V	18	35	50	65
	415/460V	37	50	65	85
	380V	42	65	70	100
	220/250V	50	75	85	125
DC	500V(3P)	10	20	40	40
	250V(2P)	10	20	40	40
I _{cs} =% × I _{cu}		100	100	100	75
Dimensions (mm)	W × H × D	140 × 257 × 109mm (Fig. 4)			
More info.	Ratings	40 page			
	Curves	75 page			
	Drawings	79 page			

Type	400AF	800AF
ABN	ABN400c 37kA	ABN800c 37kA
ABS	ABS400c 50kA	ABS800c 65kA
ABH	ABH400c 65kA	
ABL	ABL400c 85kA	ABL800c 85kA



800 AF			
	N-Type	S-Type	L-Type
	ABN802c	ABS802c	ABL802c
	ABN803c	ABS803c	ABL803c
	ABN804c	ABS804c	ABL804c
	500, 630, 700, 800		
	690	690	690
	500	500	500
	750	750	750
	8	8	8
	8	10	14
	25	45	65
	37	65	85
	45	75	100
	50	85	125
	10	20	40
	10	20	40
	100	100	75
	210 × 280 × 109mm (Fig. 5)		
	42 page		
	75 page		
	80 page		

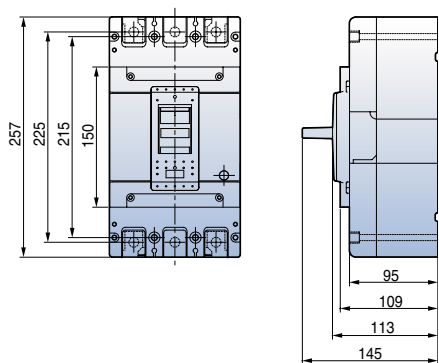

(Fig. 4)

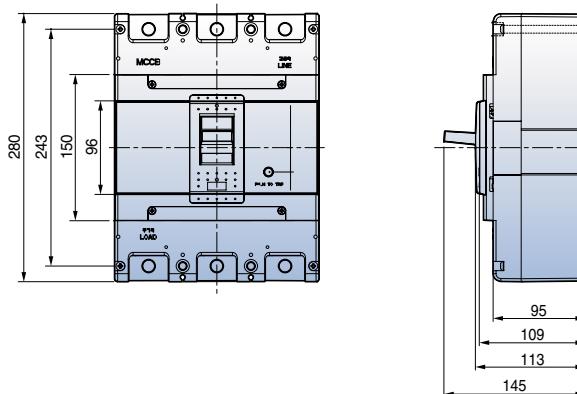

(Fig. 5)

Quick selection table

Earth Leakage Circuit Breakers



ELCBs

AF		30AF	50AF			60AF	
Type		S-Type	N-Type	S-Type	H-Type	N-Type	S-Type
Type and Pole	2-pole	-	EBN52c	-	-	-	-
	3-pole	EBS33c	EBN53c	EBS53c	EBH53c	EBN63c	EBS63c
	4-pole	EBS34c	-	EBS54c	EBH54c	-	EBS64c
Protective function		Overload, Short-circuit and Ground fault	Overload, Short-circuit and Ground fault	Overload, Short-circuit and Ground fault	Overload, Short-circuit and Ground fault	Overload, Short-circuit and Ground fault	Overload, Short-circuit and Ground fault
Rated current, I _n	A	15, 20, 30	15, 20, 30, 40, 50	15, 20, 30, 40, 50	15, 20, 30, 40, 50	60	60
Rated residual current, I _{Δn}	mA	30, 100/200/500mA	30, 100/200/500mA	30, 100/200/500mA	30, 100/200/500mA	30, 100/200/500mA	30, 100/200/500mA
Rated operational voltage, U _e	AC(V)	220/460	220/460	220/460	220/460	220/460	220/460
Rated impulse withstand voltage, U _{imp}	kV	6	6	6	6	6	6
Residual current off-time at I _{Δn}	sec	≤0.1 sec	≤0.1 sec	≤0.1 sec	≤0.1 sec	≤0.1 sec	≤0.1 sec

Rated short-circuit breaking capacity (I_{cu}) kA (Sym), KSC8321, IEC 60947-2

AC	415/460V	14	14	18	50	14	18
	220/250V	30	30	35	100	30	35
Dimensions (mm)	W × H × D	75 × 130 × 60mm (Fig. 1)	75 × 130 × 60mm (Fig. 1)	90 × 155 × 60mm (Fig. 2)	90 × 155 × 60mm (Fig. 2)	75 × 130 × 60mm (Fig. 1)	75 × 130 × 60mm (Fig. 1)
More info.	Ratings	44 page	46 page	46 page	46 page	48 page	48 page
	Curves	72 page	72 page	72 page	73 page	72 page	72 page
	Drawings	81 page	81 page	81 page	82 page	81 page	81 page

AF Type	30AF	50AF	60AF	100AF	125AF	250AF
EBN		EBN50c 14kA	EBN60c 14kA	EBN100c 18kA		EBN250c 26kA
EBS	EBS30c 14kA	EBS50c 18kA	EBS60c 18kA		EBS125c 37kA	EBS250c 37kA
EBH		EBH50c 50kA			EBH125c 50kA	EBH250c 50kA

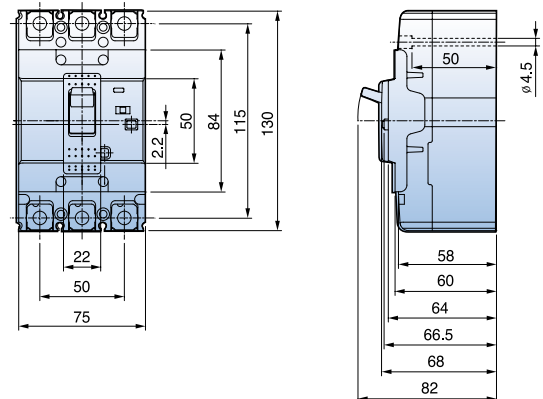

(Fig. 1)



100AF		125AF		250AF		
N-Type	S-Type	H-Type	N-Type	S-Type	H-Type	
EBN102c	-	-	EBN202c	-	-	
EBN103c	EBS103c	EBH103c	EBN203c	EBS203c	EBH203c	
EBN104c	EBS104c	EBH104c	-	EBS204c	EBH204c	
Overload, Short-circuit and Ground fault	Overload, Short-circuit and Ground fault		Overload, Short-circuit and Ground fault			
60, 75, 100	15, 20, 30, 40, 50, 60, 75, 100, 125		100, 125, 150, 175, 200, 225, 250			
30, 100/200/500mA	30, 100/200/500mA		30, 100/200/500mA			
220/460	220/460		220/460			
6	6		6			
≤0.1 sec	≤0.1 sec		≤0.1 sec			
18	37	50	26	37	50	
35	85	100	65	85	100	
75 × 130 × 60mm (Fig. 1)	90 × 155 × 60mm (Fig. 2)		105 × 165 × 60mm (Fig. 3)			
50 page	52 page	52 page	54 page	54 page	54 page	
72 page	73 page	73 page	74 page	74 page	74 page	
81 page	82 page	82 page	83 page	83 page	83 page	

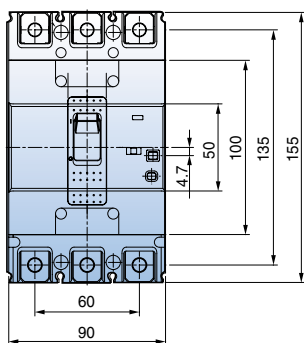

(Fig. 2)

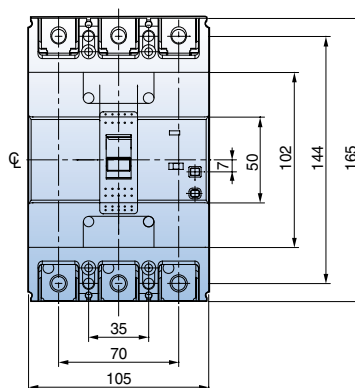
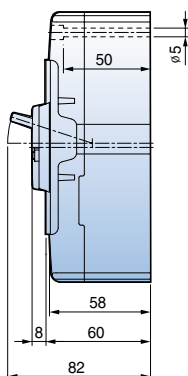

(Fig. 3)

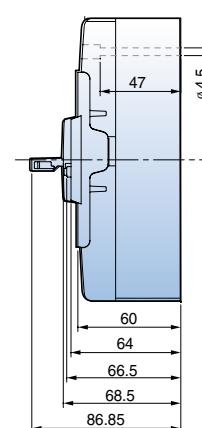

Quick selection table

Earth Leakage Circuit Breakers



ELCBs

AF		400AF			
Type		N-Type	S-Type	H-Type	L-Type
Type and Pole	3-pole	EBN403c	EBS403c	EBH403c	EBL403c
	4-pole	EBN404c	EBS404c	EBH404c	EBL404c
Protective function		Overload, Short-circuit and Ground fault			
Rated current, I _n	A	250, 300, 350, 400			
Rated residual current, I _{Δn}	mA	30, 100/200/500mA			
Rated operational voltage, U _e	AC(V)	220/460	220/460	220/460	220/460
Rated impulse withstand voltage, U _{imp}	kV	6	6	6	6
Residual current off-time at I _{Δn}	sec	0.1 sec	0.1 sec	0.1 sec	0.1 sec
Rated short-circuit breaking capacity (I_{cu}) kA (Sym), KSC8321, IEC 60947-2					
AC	415/460V	37	50	65	85
	220/250V	50	75	85	125
Dimensions (mm)	W × H × D	100	100	100	75
More info.	Ratings	140 × 257 × 109mm (Fig. 4)			
	Curves	56 page			
	Drawings	75 page			
		84 page			

Type \ AF	400AF	800AF
EBN	EBN400c 37kA	EBN800c 37kA
EBS	EBS400c 50kA	EBS800c 65kA
EBH	EBH400c 65kA	
EBL	EBL400c 85kA	EBL800c 85kA



800 AF			
N-Type	S-Type	L-Type	
EBN803c	EBS803c	EBL803c	
-	-	-	
Overload, Short-circuit and Ground fault			
500, 630, 700, 800			
30, 100/200/500mA			
220/460	220/460	220/460	
6	6	6	
0.1 sec	0.1 sec	0.1 sec	
37	65	85	
50	85	125	
100	100	75	
210 × 280 × 109mm (Fig. 5)			
58 page			
75 page			
85 page			

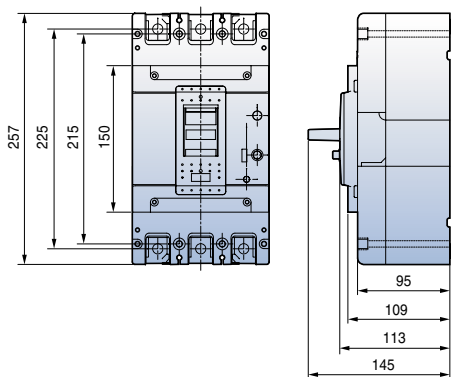

(Fig. 4)

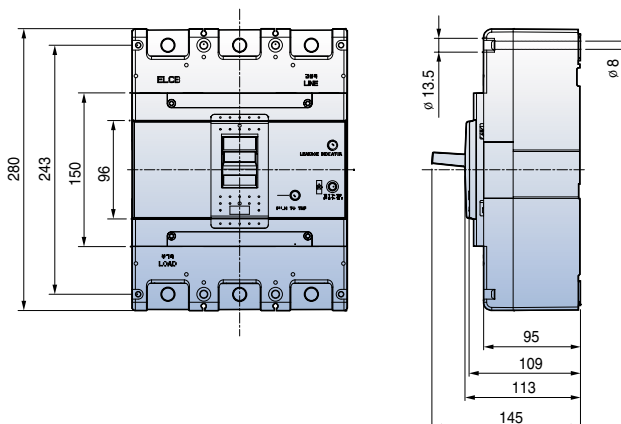

(Fig. 5)

30AF MCCB

ABS30c



ABS52c



ABS53c



ABS54c

Ratings

Frame size		30AF			
Type and Pole		S-Type			
2-pole		ABS32c			
3-pole		ABS33c			
4-pole		ABS34c			
Rated current, I _n		(3-5-10)-15-20-30A			
Rated operational voltage, U _e		AC: 690V			
		DC: 500V			
Rated insulation voltage, U _i		AC: 750V			
Rated impulse withstand voltage, U _{imp}		8kV			
Rated short-circuit breaking capacity, I_{cu}		S-Type			
AC 690V		2.5 kA			
480/500V		7.5 kA			
IEC 60947-2 (I _{cu}) 460V		14 (10)kA			
415V		14 (10)kA			
380V		18 (14)kA			
220/250V		30 (25)kA			
DC 500V(3P)		5 kA			
250V(2P)		5 kA			
Protective function		Overload, Short-circuit			
Type of trip unit		Thermal-Magnetic			
Magnetic trip range		400A			
Endurance		Mechanical		25000 operations	
		Electrical		10000 operations	
Connection		Standard		Front connection	
		Optional		Rear connection	
				Plug-in	
Mounting		Standard		Screw fixing	
Dimensions (mm)		Pole	2p	3p	4p
		a	50	75	100
		b	130	130	130
		c1 <i>Note)</i>	60	60	60
		c2 <i>Note)</i>	64	64	64
		d	82	82	82
		Weight, kg	Standard	0.5	0.7
Certification		Pole	2p	3p	4p
CE marking			○	○	○

Note) Depth by door cut size : c1 for large cut, c2 for small cut

For more information

- Drawings ▶ 76 page
- Trip curves ▶ 72 page
- Accessories ▶ 60 page
- Connection and mounting ▶ 89 page

Ordering types

Breaker types

ABS type (10kA/460V)			
Rated current, In	2-pole	3-pole	4-pole
3 A	ABS32c/3	ABS33c/3	ABS34c/3
5 A	ABS32c/5	ABS33c/5	ABS34c/5
10 A	ABS32c/10	ABS33c/10	ABS34c/10

ABS type (14kA/460V)			
Rated current, In	2-pole	3-pole	4-pole
15 A	ABS32c/15	ABS33c/15	ABS34c/15
20 A	ABS32c/20	ABS33c/20	ABS34c/20
30 A	ABS32c/30	ABS33c/30	ABS34c/30

Accessories

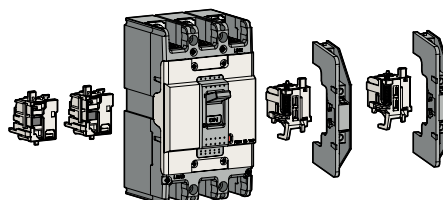

Electrical auxiliaries

AX	Auxiliary Switch	
AL	Alarm Switch	
AX+AL	Combination switch	
SHT	Shunt Trip	
UVT	Undervoltage trip	

Maximum possibilities

T-position	One of above auxiliaries
R-position	Option of AX or AL or AX+AL

Note) For more detail see 60 page

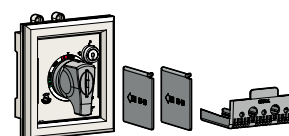
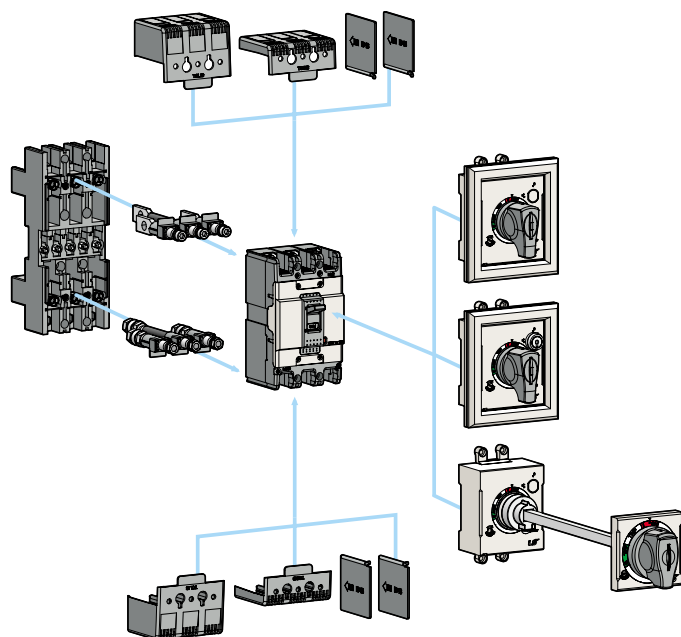

External accessories

ABS30c	Name
IB13	Insulation barrier
TCL13	Terminal cover (Long)
TCS13	Terminal cover (Short)
DH100	Rotary handle (Direct)
DHK100	Rotary handle (Direct, Key lock)
EH100	Rotary handle (Extended)
RTR1	Rear terminal (Round)
PB-A3	Plug-in kit
PHL100C	Pad handle lock

Note) For more detail see 65 page

50AF MCCB

ABN50c, ABS50c, ABH50c



ABS52c



ABS53c



Ratings

Frame size		50AF									
Type and Pole		N-Type			S-Type			H-Type			
2-pole		ABN52c			ABS52c			ABH52c			
3-pole		ABN53c			ABS53c			ABH53c			
4-pole		ABN54c			ABS54c			ABH54c			
Rated current, I _n		15-20-30-40-50A									
Rated operational voltage, U _e		AC: 690V									
		DC: 500V									
Rated insulation voltage, U _i		AC: 750V									
Rated impulse withstand voltage, U _{imp}		8kV									
Rated short-circuit breaking capacity, I_{cu}		N-Type			S-Type			H-Type			
AC 690V		2.5kA			5kA			10kA			
480/500V		7.5kA			10kA			35kA			
IEC 60947-2 (I _{cu})		460V			14kA			18kA			
IEC 60947-2 (I _{cs})		415V			14kA			18kA			
380V		18kA			22kA			50kA			
220/250V		30kA			35kA			100kA			
DC 500V(3P)		5kA			10kA			30kA			
250V(2P)		5kA			10kA			30kA			
Protective function		Overload, Short-circuit									
Type of trip unit		Thermal-Magnetic									
Magnetic trip range		12 × I _n (30A and under: 400A)									
Endurance		Mechanical			25000 operations						
		Electrical			10000 operations						
Connection		Standard			Front connection						
		Optional			Rear connection						
		Plug-in									
Mounting		Standard			Screw fixing						
Dimensions (mm)		Pole	2p	3p	4p	2p	3p	4p	2p	3p	4p
		a	50	75	100	50	75	100	60	90	120
		b	130			130			155		
		c1 <i>Note)</i>	60			60			60		
		c2 <i>Note)</i>	64			64			64		
		d	82			82			82		
		Weight, kg	Standard	0.5	0.7	0.9	0.5	0.7	0.9	0.7	1
Certification		Pole	2p	3p	4p	2p	3p	4p	2p	3p	4p
CE marking		☐			○			○			

Note) Depth by door cut size : c1 for large cut, c2 for small cut

For more information

- Drawings ▶ 76 page
- Trip curves ▶ 72, 73 page
- Accessories ▶ 60 page
- Connection and mounting ▶ 89 page

Ordering types

Breaker types

ABN type (14kA/460V)			
Rated current, In	2-pole	3-pole	4-pole
15 A	ABN52c/15	ABN53c/15	ABN54c/15
20 A	ABN52c/20	ABN53c/20	ABN54c/20
30 A	ABN52c/30	ABN53c/30	ABN54c/30
40 A	ABN52c/40	ABN53c/40	ABN54c/40
50 A	ABN52c/50	ABN53c/50	ABN54c/50

ABS type (18kA/460V)			
Rated current, In	2-pole	3-pole	4-pole
15 A	ABS52c/15	ABS53c/15	ABS54c/15
20 A	ABS52c/20	ABS53c/20	ABS54c/20
30 A	ABS52c/30	ABS53c/30	ABS54c/30
40 A	ABS52c/40	ABS53c/40	ABS54c/40
50 A	ABS52c/50	ABS53c/50	ABS54c/50

ABH type (50kA/460V)			
Rated current, In	2-pole	3-pole	4-pole
15 A	ABH52c/15	ABH53c/15	ABH54c/15
20 A	ABH52c/20	ABH53c/20	ABH54c/20
30 A	ABH52c/30	ABH53c/30	ABH54c/30
40 A	ABH52c/40	ABH53c/40	ABH54c/40
50 A	ABH52c/50	ABH53c/50	ABH54c/50

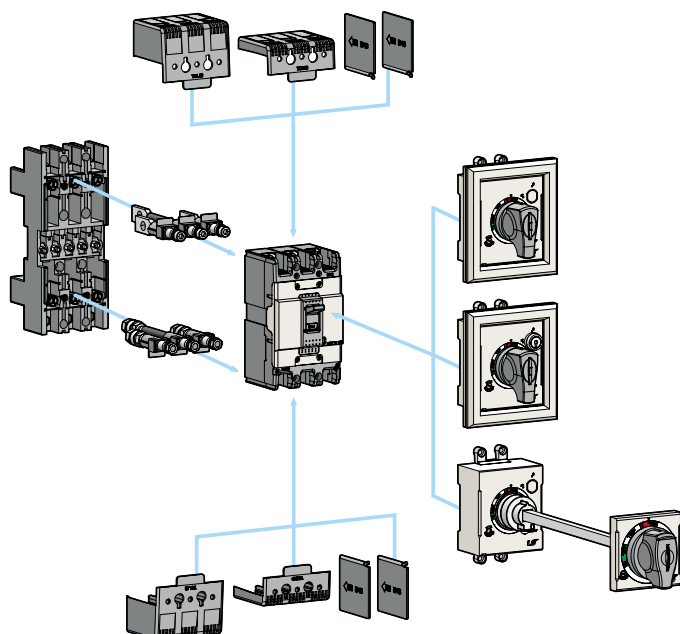

Accessories

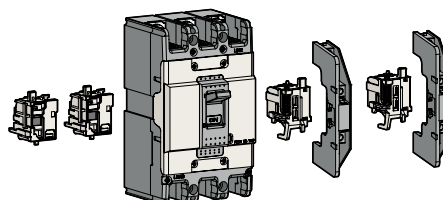

Electrical auxiliaries

AX	Auxiliary Switch	
AL	Alarm Switch	
AX+AL	Combination switch	
SHT	Shunt Trip	
UVT	Undervoltage trip	

Maximum possibilities

T-position	One of above auxiliaries
R-position	Option of AX or AL or AX+AL

Note) For more detail see 60 page

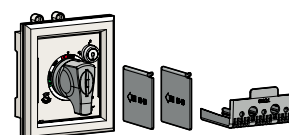

External accessories

ABN50c ABS50c	ABH50c	Name
IB13	IB23	Insulation barrier
TCL13	TCL23	Terminal cover (Long)
TCS13	TCS23	Terminal cover (Short)
DH100	DH125	Rotary handle (Direct)
DHK100	DHK125	Rotary handle (Direct, Key lock)
EH100	EH125	Rotary handle (Extended)
-	RTB2	Rear terminal (Bar)
RTR1	RTR2	Rear terminal (Round)
PB-A3	PB-C3	Plug-in kit
PHL100	PHL125	Pad handle lock

Note) For more detail see 65 page

60AF MCCB

ABN60c, ABS60c



ABS62c



ABS63c



ABS64c

Ratings

Frame size		60AF						
Type and Pole		N-Type			S-Type			
	2-pole	ABN62c			ABS62c			
	3-pole	ABN63c			ABS63c			
	4-pole	ABN64c			ABS64c			
Rated current, I _n		15-20-30-40-50-60A						
Rated operational voltage, U _e		AC: 690V						
		DC: 500V						
Rated insulation voltage, U _i		AC: 750V						
Rated impulse withstand voltage, U _{imp}		8kV						
Rated short-circuit breaking capacity, I_{cu}		N-Type			S-Type			
AC	690V	2.5kA			5kA			
	480/500V	7.5kA			10kA			
IEC 60947-2 (I _{cu})		460V			14kA			
I _{cs} =100%I _{cu}	415V	14kA			18kA			
	380V	18kA			22kA			
	220/250V	30kA			35kA			
DC	500V(3P)	5kA			10kA			
	250V(2P)	5kA			10kA			
Protective function		Overload, Short-circuit						
Type of trip unit		Thermal-Magnetic						
Magnetic trip range		12 × I _n (30A and under: 400A)						
Endurance	Mechanical	25000 operations						
	Electrical	10000 operations						
Connection	Standard	Front connection						
	Optional	Rear connection						
Mounting		Screw fixing						
Dimensions (mm)		Pole	2p	3p	4p	2p	3p	4p
	a		50	75	100	50	75	100
	b			130			130	
	c1 <small>Note)</small>			60			60	
	c2 <small>Note)</small>			64			64	
	d			82			82	
	Weight, kg	Standard	0.5	0.7	0.9	0.5	0.7	0.9
Certification		Pole	2p	3p	4p	2p	3p	4p
CE marking			☐	○		○		

Note) Depth by door cut size : c1 for large cut, c2 for small cut

For more information

- Drawings ▶ 76 page
- Trip curves ▶ 72 page
- Accessories ▶ 60 page
- Connection and mounting ▶ 89 page

Ordering types

Breaker types

ABN type (14kA/460V)			
Rated current, In	2-pole	3-pole	4-pole
15 A	ABN62c/15	ABN63c/15	ABN64c/15
20 A	ABN62c/20	ABN63c/20	ABN64c/20
30 A	ABN62c/30	ABN63c/30	ABN64c/30
40 A	ABN62c/40	ABN63c/40	ABN64c/40
50 A	ABN62c/50	ABN63c/50	ABN64c/50
60 A	ABN62c/60	ABN63c/60	ABN64c/60

ABS type (18kA/460V)			
Rated current, In	2-pole	3-pole	4-pole
15 A	ABS62c/15	ABS63c/15	ABS64c/15
20 A	ABS62c/20	ABS63c/20	ABS64c/20
30 A	ABS62c/30	ABS63c/30	ABS64c/30
40 A	ABS62c/40	ABS63c/40	ABS64c/40
50 A	ABS62c/50	ABS63c/50	ABS64c/50
60 A	ABS62c/60	ABS63c/60	ABS64c/60

Accessories

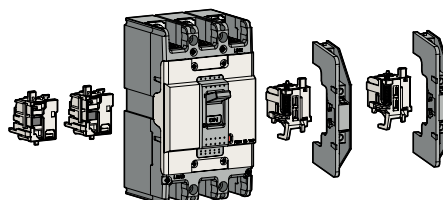

Electrical auxiliaries

AX	Auxiliary Switch	
AL	Alarm Switch	
AX+AL	Combination switch	
SHT	Shunt Trip	
UVT	Undervoltage trip	

Maximum possibilities

T-position	One of above auxiliaries
R-position	Option of AX or AL or AX+AL

Note) For more detail see 60 page

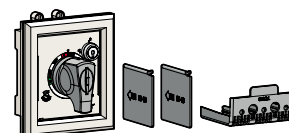
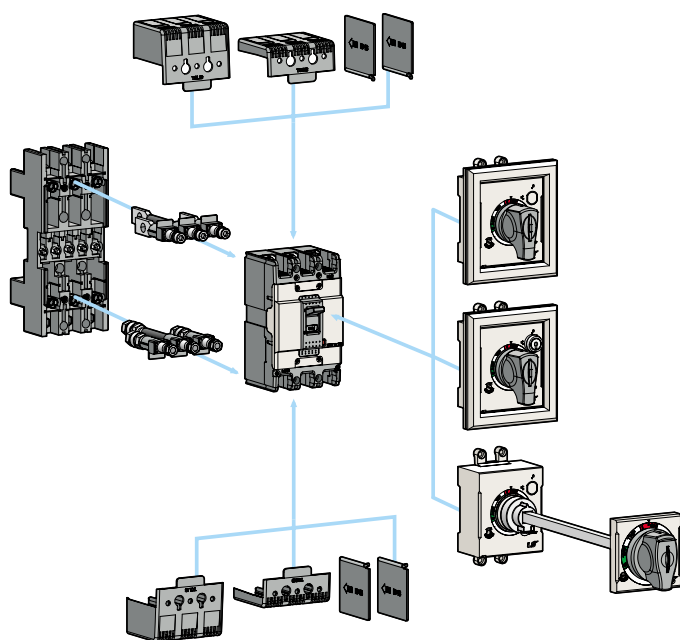

External accessories

ABS60c ABN60c	Name
IB13	Insulation barrier
TCL13	Terminal cover (Long)
TCS13	Terminal cover (Short)
DH100	Rotary handle (Direct)
DHK100	Rotary handle (Direct, Key lock)
EH100	Rotary handle (Extended)
RTB1	Rear terminal (Bar)
RTR1	Rear terminal (Round)
PB-A3	Plug-in kit
PHL100	Pad handle lock

Note) For more detail see 65 page

100AF MCCB

ABN100c

Metasol



ABN102c



ABN103c



ABN104c

Ratings

Frame size		100AF			
Type and Pole		N-Type			
2-pole		ABN102c			
3-pole		ABN103c			
4-pole		ABN104c			
Rated current, I _n		15-20-30-40-50-60-75-100A			
Rated operational voltage, U _e		AC: 690V			
		DC: 500V			
Rated insulation voltage, U _i		AC: 750V			
Rated impulse withstand voltage, U _{imp}		8kV			
Rated short-circuit breaking capacity, I_{cu}		N-Type			
AC	690V	5kA			
	480/500V	10kA			
IEC 60947-2 (I _{cu})		460V			18kA
I _{cs} =100%I _{cu}	415V	18kA			
	380V	22kA			
	220/250V	35kA			
	DC	500V(3P)	10kA		
	250V(2P)	10kA			
Protective function		Overload, Short-circuit			
Type of trip unit		Thermal-Magnetic			
Magnetic trip range		400A			
Endurance	Mechanical	25000 operations			
	Electrical	10000 operations			
Connection	Standard	Front connection			
	Optional	Rear connection			
		Plug-in			
Mounting	Standard	Screw fixing			
Dimensions (mm)		Pole	2p	3p	4p
	a	50	75	100	
	b	130	130	130	
	c1 <i>Note)</i>	60	60	60	
	c2 <i>Note)</i>	64	64	64	
	d	82	82	82	
	Weight, kg	Standard	0.5	0.7	0.9
Certification		Pole	2p	3p	4p
CE marking			○	○	○

Note) Depth by door cut size : c1 for large cut, c2 for small cut

For more information

- Drawings ▶ 76 page
- Trip curves ▶ 72 page
- Accessories ▶ 60 page
- Connection and mounting ▶ 89 page

Ordering types

Breaker types

ABN type (14kA/460V)			
Rated current, I _n	2-pole	3-pole	4-pole
15 A	ABN102c/15	ABN103c/15	ABN104c/15
20 A	ABN102c/20	ABN103c/20	ABN104c/20
30 A	ABN102c/30	ABN103c/30	ABN104c/30
40 A	ABN102c/40	ABN103c/40	ABN104c/40
50 A	ABN102c/50	ABN103c/50	ABN104c/50
60 A	ABN102c/60	ABN103c/60	ABN104c/60
75 A	ABN102c/75	ABN103c/75	ABN104c/75
100 A	ABN102c/100	ABN103c/100	ABN104c/100

Accessories

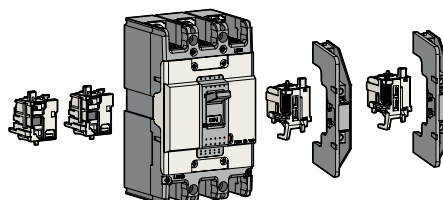

Electrical auxiliaries

AX	Auxiliary Switch	
AL	Alarm Switch	
AX+AL	Combination switch	
SHT	Shunt Trip	
UVT	Undervoltage trip	

Maximum possibilities

T-position	One of above auxiliaries
R-position	Option of AX or AL or AX+AL

Note) For more detail see 60 page

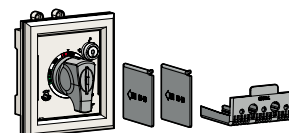
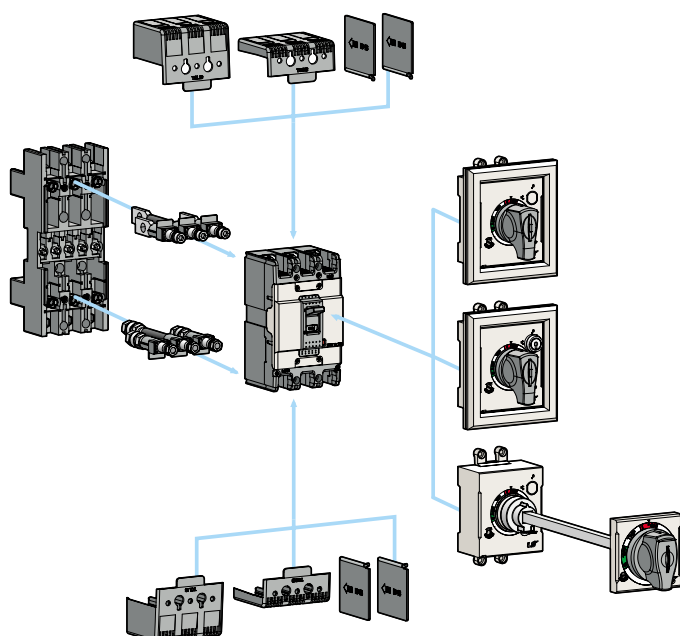

External accessories

ABN100c	Name
IB13	Insulation barrier
TCL13	Terminal cover (Long)
TCS13	Terminal cover (Short)
DH100	Rotary handle (Direct)
DHK100	Rotary handle (Direct, Key lock)
EH100	Rotary handle (Extended)
RTB1	Rear terminal (Bar)
RTR1	Rear terminal (Round)
PB-A3	Plug-in kit
PHL100	Pad handle lock

Note) For more detail see 65 page

125AF MCCB

ABS125c, ABH125c



ABS102c



ABS103c



ABS104c

For more information

- Drawings ▶ 77 page
- Trip curves ▶ 73 page
- Accessories ▶ 60 page
- Connection and mounting ▶ 89 page

Ratings

Frame size		125AF						
Type and Pole		S-Type			H-Type			
	2-pole	ABS102c			ABH102c			
	3-pole	ABS103c			ABH103c			
	4-pole	ABS104c			ABH104c			
Rated current, I _n		15-20-30-40-50-60-75-100-125A						
Rated operational voltage, U _e		AC: 690V						
		DC: 500V						
Rated insulation voltage, U _i		AC: 750V						
Rated impulse withstand voltage, U _{imp}		8kV						
Rated short-circuit breaking capacity, I_{cu}		S-Type			H-Type			
AC	690V	8kA			10kA			
	480/500V	26kA			35kA			
IEC 60947-2 (I _{cu})		460V			37kA			
I _{cs} =100%I _{cu}	415V	37kA			50kA			
	380V	42kA			50kA			
	220/250V	85kA			100kA			
DC	500V(3P)	20kA			30kA			
	250V(2P)	20kA			30kA			
Protective function		Overload, Short-circuit						
Type of trip unit		Thermal-Magnetic						
Magnetic trip range		12 × I _n (30A and under: 400A)						
Endurance	Mechanical	25000 operations						
	Electrical	10000 operations						
Connection	Standard	Front connection						
	Optional	Rear connection						
Mounting		Screw fixing						
Dimensions (mm)		Pole	2p	3p	4p	2p	3p	4p
		a	60	90	120	60	90	120
		b	155			155		
		c1 <i>Note)</i>	60			60		
		c2 <i>Note)</i>	64			64		
		d	82			82		
		Weight, kg	Standard	0.7	1	1.2	0.7	1
Certification		Pole	2p	3p	4p	2p	3p	4p
CE marking			○			○		

Note) Depth by door cut size : c1 for large cut, c2 for small cut

Ordering types

Breaker types

ABS type (37kA/460V)			
Rated current, In	2-pole	3-pole	4-pole
15 A	ABS102c/15	ABS103c/15	ABS104c/15
20 A	ABS102c/20	ABS103c/20	ABS104c/20
30 A	ABS102c/30	ABS103c/30	ABS104c/30
40 A	ABS102c/40	ABS103c/40	ABS104c/40
50 A	ABS102c/50	ABS103c/50	ABS104c/50
60 A	ABS102c/60	ABS103c/60	ABS104c/60
75 A	ABS102c/75	ABS103c/75	ABS104c/75
100 A	ABS102c/100	ABS103c/100	ABS104c/100
125 A	ABS102c/125	ABS103c/125	ABS104c/125

ABH type (50kA/460V)			
Rated current, In	2-pole	3-pole	4-pole
15 A	ABH102c/15	ABH103c/15	ABH104c/15
20 A	ABH102c/20	ABH103c/20	ABH104c/20
30 A	ABH102c/30	ABH103c/30	ABH104c/30
40 A	ABH102c/40	ABH103c/40	ABH104c/40
50 A	ABH102c/50	ABH103c/50	ABH104c/50
60 A	ABH102c/60	ABH103c/60	ABH104c/60
75 A	ABH102c/75	ABH103c/75	ABH104c/75
100 A	ABH102c/100	ABH103c/100	ABH104c/100
125 A	ABH102c/125	ABH103c/125	ABH104c/125

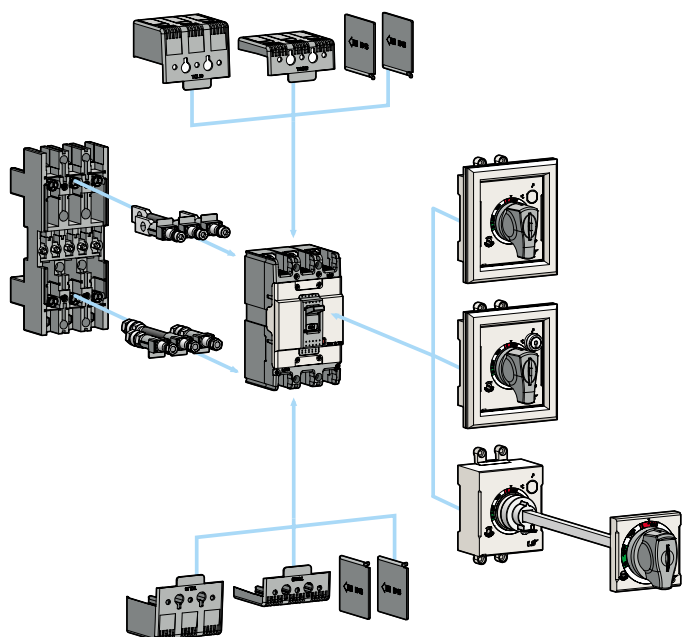

Accessories

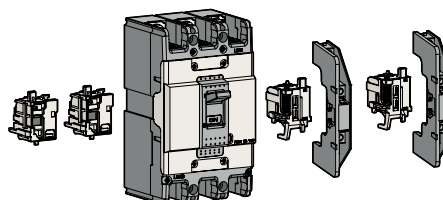

Electrical auxiliaries

AX	Auxiliary Switch	
AL	Alarm Switch	
AX+AL	Combination switch	
SHT	Shunt Trip	
UVT	Undervoltage trip	

Maximum possibilities

T-position	One of above auxiliaries
R-position	Option of AX or AL or AX+AL

Note) For more detail see 60 page

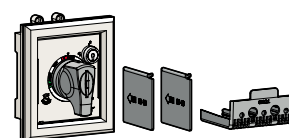

External accessories

ABS125c ABH125c	Name
IB23	Insulation barrier
TCL23	Terminal cover (Long)
TCS23	Terminal cover (Short)
DH125	Rotary handle (Direct)
DHK125	Rotary handle (Direct, Key lock)
EH125	Rotary handle (Extended)
RTB2	Rear terminal (Bar)
RTR2	Rear terminal (Round)
PB-C3	Plug-in kit
PHL125	Pad handle lock

Note) For more detail see 65 page

250AF MCCB

ABN250c, ABS250c, ABH250c



ABS202c



ABS203c



ABS204c

Ratings

Frame size		250AF									
Type and Pole		N-Type			S-Type			H-Type			
	2-pole	ABN202c			ABS202c			ABH202c			
	3-pole	ABN203c			ABS203c			ABH203c			
	4-pole	ABN204c			ABS204c			ABH204c			
Rated current, I _n		100-125-150-175-200-225-250A									
Rated operational voltage, U _e		AC: 690V									
		DC: 500V									
Rated insulation voltage, U _i		AC: 750V									
Rated impulse withstand voltage, U _{imp}		8kV									
Rated short-circuit breaking capacity, I_{cu}		N-Type			S-Type			H-Type			
	AC	690V	8kA			8kA			10kA		
		480/500V	18kA			26kA			35kA		
IEC 60947-2 (I _{cu})		460V	26kA			37kA			50kA		
I _{cs} =100%I _{cu}	415V	26kA			37kA			50kA			
		380V			30kA			42kA			
	220/250V		65kA			85kA			100kA		
	DC	500V(3P)	10kA			20kA			30kA		
250V(2P)		10kA			20kA			30kA			
Protective function		Overload, Short-circuit									
Type of trip unit		Thermal-Magnetic									
Magnetic trip range		12 × I _n									
Endurance	Mechanical	25000 operations									
	Electrical	10000 operations									
Connection	Standard	Front connection									
	Optional	Rear connection									
		Plug-in									
Mounting	Standard	Screw fixing									
Dimensions (mm)		Pole	2p	3p	4p	2p	3p	4p	2p	3p	4p
		a	105	105	140	105	105	140	105	105	140
		b	165			165			165		
		c1 <i>Note)</i>	60			60			60		
		c2 <i>Note)</i>	64			64			64		
		d	87			87			87		
		Weight, kg	Standard	1.1	1.2	1.6	1.1	1.2	1.6	1.1	1.2
Certification		Pole	2p	3p	4p	2p	3p	4p	2p	3p	4p
CE marking			○			○			○		

Note) Depth by door cut size : c1 for large cut, c2 for small cut

For more information

- Drawings ▶ 78 page
- Trip curves ▶ 74 page
- Accessories ▶ 60 page
- Connection and mounting ▶ 89 page

Ordering types

Breaker types

ABN type (25kA/460V)			
Rated current, In	2-pole	3-pole	4-pole
100 A	ABN202c/100	ABN203c/100	ABN204c/100
125 A	ABN202c/125	ABN203c/125	ABN204c/125
150 A	ABN202c/150	ABN203c/150	ABN204c/150
175 A	ABN202c/175	ABN203c/175	ABN204c/175
200 A	ABN202c/200	ABN203c/200	ABN204c/200
225 A	ABN202c/225	ABN203c/225	ABN204c/225
250 A	ABN202c/250	ABN203c/250	ABN204c/250

ABS type (37kA/460V)			
Rated current, In	2-pole	3-pole	4-pole
100 A	ABS202c/100	ABS203c/100	ABS204c/100
125 A	ABS202c/125	ABS203c/125	ABS204c/125
150 A	ABS202c/150	ABS203c/150	ABS204c/150
175 A	ABS202c/175	ABS203c/175	ABS204c/175
200 A	ABS202c/200	ABS203c/200	ABS204c/200
225 A	ABS202c/225	ABS203c/225	ABS204c/225
250 A	ABS202c/250	ABS203c/250	ABS204c/250

ABH type (50kA/460V)			
Rated current, In	2-pole	3-pole	4-pole
100 A	ABH202c/100	ABH203c/100	ABH204c/100
125 A	ABH202c/125	ABH203c/125	ABH204c/125
150 A	ABH202c/150	ABH203c/150	ABH204c/150
175 A	ABH202c/175	ABH203c/175	ABH204c/175
200 A	ABH202c/200	ABH203c/200	ABH204c/200
225 A	ABH202c/225	ABH203c/225	ABH204c/225
250 A	ABH202c/250	ABH203c/250	ABH204c/250

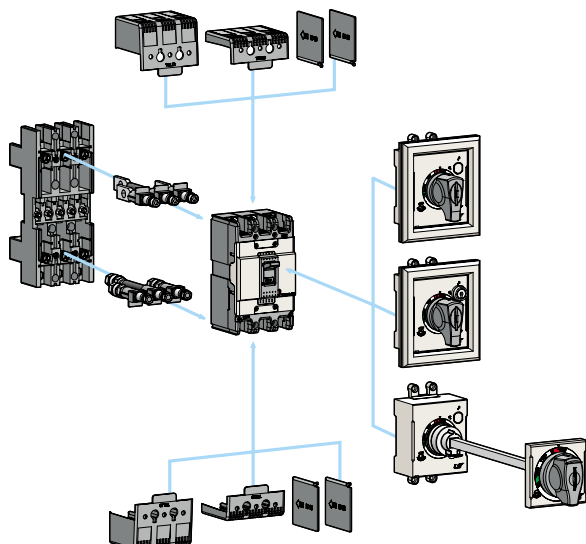

Accessories

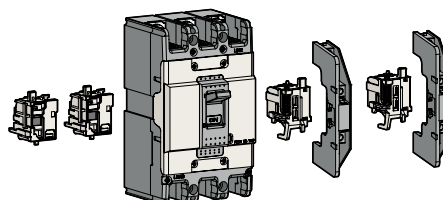

Electrical auxiliaries

AX	Auxiliary Switch	
AL	Alarm Switch	
AX+AL	Combination switch	
SHT	Shunt Trip	
UVT	Undervoltage trip	

Maximum possibilities

T-position	One of above auxiliaries
R-position	Option of AX or AL or AX+AL

Note) For more detail see 60 page

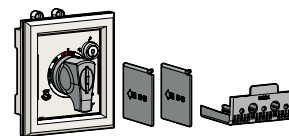

External accessories

ABH250c	Name
B33	Insulation barrier
TCL33	Terminal cover (Long)
TCS33	Terminal cover (Short)
DH250	Rotary handle (Direct)
DHK250	Rotary handle (Direct, Key lock)
EH250	Rotary handle (Extended)
RTB3	Rear terminal (Bar)
RTR3	Rear terminal (Round)
PBA250C	Plug-in kit
PHL250	Pad handle lock

Note) For more detail see 65 page

400AF MCCB

ABN400c, ABS400c, ABH400c, ABL400c



ABS403c



ABL404c

Ratings

Frame size		400AF													
Type and Pole		N-Type			S-Type			H-Type			L-Type				
2-pole		ABN402c			ABS402c			ABH402c			ABL402c				
3-pole		ABN403c			ABS403c			ABH403c			ABL403c				
4-pole		ABN404c			ABS404c			ABH404c			ABL404c				
Rated current, I _n		250-300-350-400A													
Rated operational voltage, U _e		AC: 690V													
		DC: 500V													
Rated insulation voltage, U _i		AC: 750V													
Rated impulse withstand voltage, U _{imp}		8kV													
Rated short-circuit breaking capacity, I_{cu}		N-Type			S-Type			H-Type			L-Type				
AC 690V		5kA			8kA			10kA			14kA				
480/500V		18kA			35kA			50kA			65kA				
IEC 60947-2 (I _{cu})		415/460V			37kA			50kA			65kA				
380V		42kA			65kA			70kA			100kA				
220/250V		50kA			75kA			85kA			125kA				
DC 500V(3P)		10kA			20kA			40kA			40kA				
250V(3P)		10kA			20kA			40kA			40kA				
I _{cs} =100%I _{cu}		125V			100%			100%			75%				
Protective function		Overload, Short-circuit													
Type of trip unit		Thermal-Magnetic													
Magnetic trip range		8~12I _n													
Endurance		Mechanical			4000 operations										
		Electrical			1000 operations										
Connection		Standard			Front connection										
		Optional			Rear connection										
					Plug-in										
Mounting		Standard			Screw fixing										
Dimensions (mm)		Pole		2p	3p	4p	2p	3p	4p	2p	3p	4p	2p	3p	4p
a				140	140	180	140	140	180	140	140	180	140	140	180
b				257			257			257			257		
c1 <small>Note)</small>				109			109			109			109		
c2 <small>Note)</small>				113			113			113			113		
d				145			145			145			145		
Weight, kg		Standard		5.2	6.2	7.8	5.2	6.2	7.8	5.2	6.2	7.8	5.2	6.2	7.8
Certification		Pole		2p	3p	4p	2p	3p	4p	2p	3p	4p	2p	3p	4p
CE marking		CE		○			○			○			○		

Note) Depth by door cut size : c1 for large cut, c2 for small cut

For more information

- Drawings ▶ 79 page
- Trip curves ▶ 75 page
- Accessories ▶ 61 page
- Connection and mounting ▶ 90 page

Ordering types

Breaker types

ABN type (37kA/460V)			
Rated current, In	2-pole	3-pole	4-pole
250 A	ABN402c/250	ABN403c/250	ABN404c/250
300 A	ABN402c/300	ABN403c/300	ABN404c/300
350 A	ABN402c/350	ABN403c/350	ABN404c/350
400 A	ABN402c/400	ABN403c/400	ABN404c/400

ABS type (50kA/460V)			
Rated current, In	2-pole	3-pole	4-pole
250 A	ABS402c/250	ABS403c/250	ABS404c/250
300 A	ABS402c/300	ABS403c/300	ABS404c/300
350 A	ABS402c/350	ABS403c/350	ABS404c/350
400 A	ABS402c/400	ABS403c/400	ABS404c/400

ABH type(65kA/460V)			
Rated current, In	2-pole	3-pole	4-pole
250 A	ABH402c/250	ABH403c/250	ABH404c/250
300 A	ABH402c/300	ABH403c/300	ABH404c/300
350 A	ABH402c/350	ABH403c/350	ABH404c/350
400 A	ABH402c/400	ABH403c/400	ABH404c/400

ABL type(85kA/460V)			
Rated current, In	2-pole	3-pole	4-pole
250 A	ABL402c/250	ABL403c/250	ABL404c/250
300 A	ABL402c/300	ABL403c/300	ABL404c/300
350 A	ABL402c/350	ABL403c/350	ABL404c/350
400 A	ABL402c/400	ABL403c/400	ABL404c/400

Accessories

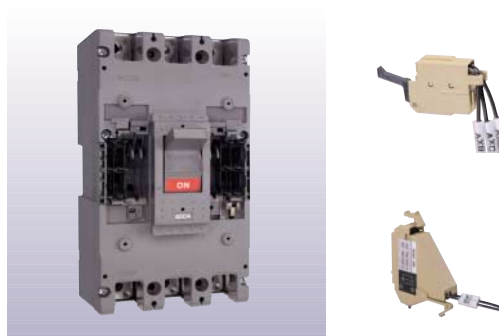

Electrical auxiliaries

AX	Auxiliary Switch	
AL	Alarm Switch	
SHT	Shunt Trip	
UVT	Undervoltage trip	

Maximum possibilities

T-position	Option of 2AX, 2AL and SHT or UVT
R-position	Option of 2AX, 2AL and SHT or UVT

Note) For more detail see 61 page

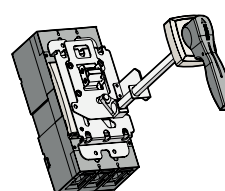

E-70U

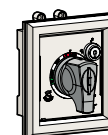

N-70

External accessories

IBL400	Insulation barrier
T1-43A	Terminal cover (Long) - 2, 3pole
T1-44A	Terminal cover (Long) - 4pole
N-70	Rotary handle (Direct)
E-70U	Rotary handle (Extended)
MI-43	Mechanical interlock - 2, 3pole
MI-44	Mechanical interlock - 4pole
X-402	Rear terminal - 2pole
X-403	Rear terminal - 3pole
X-404	Rear terminal - 4pole
PB-I3-FR	Plug-in kit

Note) For more detail see 65 page

800AF MCCB

ABN800c, ABS800c, ABL800c

Metasol



ABS803c



ABL804c

Ratings

Frame size		800AF									
Type and Pole		N-Type			S-Type			L-Type			
2-pole		ABN802c			ABS802c			ABL802c			
3-pole		ABN803c			ABS803c			ABL803c			
4-pole		ABN804c			ABS804c			ABL804c			
Rated current, In		500-630-700-800A									
Rated operational voltage, Ue		AC: 690V									
		DC: 500V									
Rated insulation voltage, Ui		AC: 750V									
Rated impulse withstand voltage, Uimp		8kV									
Rated short-circuit breaking capacity, Icu		N-Type			S-Type			L-Type			
AC 690V		8kA			10kA			14kA			
480/500V		25kA			45kA			65kA			
IEC 60947-2 (Icu)		415/460V			37kA			65kA			
380V		45kA			75kA			100kA			
220/250V		50kA			85kA			125kA			
DC 500V(3P)		10kA			20kA			40kA			
250V(3P)		10kA			20kA			40kA			
Ics=100%Icu		125V			100%			75%			
Protective function		Overload, Short-circuit									
Type of trip unit		Thermal-Magnetic									
Magnetic trip range		8-12In									
Endurance		Mechanical			2500 operations						
		Electrical			500 operations						
Connection		Standard			Front connection						
		Optional			Rear connection						
					Plug-in						
Mounting		Standard			Screw fixing						
Dimensions (mm)		Pole	2p	3p	4p	2p	3p	4p	2p	3p	4p
a			210	210	280	210	210	280	210	210	280
b				280			280			280	
c1 <small>Note)</small>				109			109			109	
c2 <small>Note)</small>				113			113			113	
d				145			145			145	
Weight, kg		Standard	11	11.5	18.2	11	11.5	18.2	11	11.5	18.2
Certification		Pole	2p	3p	4p	2p	3p	4p	2p	3p	4p
CE marking			☐	○		○			○		

Note) Depth by door cut size : c1 for large cut, c2 for small cut

For more information

- Drawings ▶ 80 page
- Trip curves ▶ 75 page
- Accessories ▶ 61 page
- Connection and mounting ▶ 90 page

Ordering types

Breaker types

ABN type (37kA/460V)			
Rated current, In	2-pole	3-pole	4-pole
500 A	ABN802c/500	ABN803c/500	ABN804c/500
630 A	ABN802c/630	ABN803c/630	ABN804c/630
700 A	ABN802c/700	ABN803c/700	ABN804c/700
800 A	ABN802c/800	ABN803c/800	ABN804c/800

ABS type (65kA/460V)			
Rated current, In	2-pole	3-pole	4-pole
500 A	ABS802c/500	ABS803c/500	ABS804c/500
630 A	ABS802c/630	ABS803c/630	ABS804c/630
700 A	ABS802c/700	ABS803c/700	ABS804c/700
800 A	ABS802c/800	ABS803c/800	ABS804c/800

ABL type(85kA/460V)			
Rated current, In	2-pole	3-pole	4-pole
500 A	ABL802c/500	ABL803c/500	ABL804c/500
630 A	ABL802c/630	ABL803c/630	ABL804c/630
700 A	ABL802c/700	ABL803c/700	ABL804c/700
800 A	ABL802c/800	ABL803c/800	ABL804c/800

Accessories

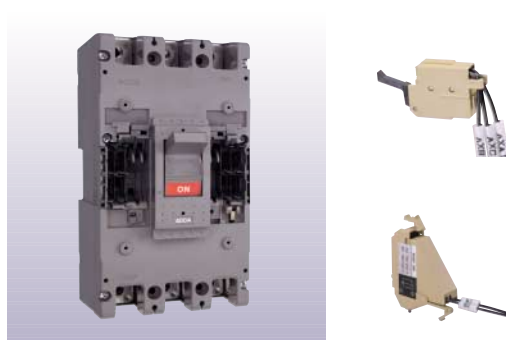

Electrical auxiliaries

AX	Auxiliary Switch
AL	Alarm Switch
SHT	Shunt Trip
UVT	Undervoltage trip

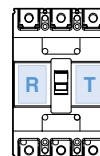

Maximum possibilities

T-position	Option of 2AX, 2AL and SHT or UVT
R-position	Option of 2AX, 2AL and SHT or UVT

Note) For more detail see 61 page

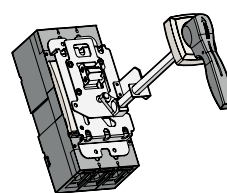

E-80U

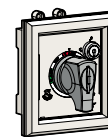

N-80

External accessories

IBL800	Insulation barrier
T1-63A	Terminal cover (Long) - 2, 3pole
T1-64A	Terminal cover (Long) - 4pole
N-80	Rotary handle (Direct)
E-80U	Rotary handle (Extended)
MI-83S	Mechanical interlock - 2, 3pole
MI-84S	Mechanical interlock - 4pole
X-802	Rear terminal - 2pole
X-803	Rear terminal - 3pole
X-804	Rear terminal - 4pole
PB-J3-FR	Plug-in kit

Note) For more detail see 65 page

30AF ELCB

EBS30c



EBS33c

Ratings

Frame size		30AF	
Type and Pole		S-Type	
	2-pole(2-sensor)	-	
	3-pole(3-sensor)	EBS33c	
	4-pole(3-sensor)	EBS34c	
Rated current, I _n		15-20-30A	
Rated residual current, I _{Δn}		30, 100/200/500mA (Adjustable)	
Residual current off-time at I _{Δn}		≤0.1 sec	
Rated operational voltage, U _e		AC: 220/460V	
Rated impulse withstand voltage, U _{imp}		6kV	
Wiring system	2-pole(2-sensor)	-	
	3-pole(3-sensor)	1 ∅ 2W, 1 ∅ 3W, 3 ∅ 3W	
	4-pole(3-sensor)	1 ∅ 2W, 1 ∅ 3W, 3 ∅ 3W, 3 ∅ 4W	
Rated short-circuit breaking capacity, I_{cu}		S-Type	
	AC 460V	14 kA	
	IEC 60947-2 (I _{cu}) 415V	14 kA	
	I _{cs} =100%I _{cu} 220/250V	30 kA	
Protective function		Overload, Short-circuit and Ground fault	
Type of trip unit		Thermal-Magnetic	
Magnetic trip range		400A	
Endurance	Mechanical	25000 operations	
	Electrical	10000 operations	
Connection	Standard	Front connection	
	Optional	Rear connection	
		Plug-in	
Mounting	Standard	Screw fixing	
Dimensions (mm)			
	Pole	3p	4p
	a	75	100
	b	130	130
	c1 <i>Note)</i>	60	60
	c2 <i>Note)</i>	64	64
	d	82	82
	Weight, kg	Standard	0.7
Certification			
	Pole	3p	4p
CE marking		○	○

Note) Depth by door cut size : c1 for large cut, c2 for small cut

For more information

- Drawings ▶ 81 page
- Trip curves ▶ 72 page
- Accessories ▶ 60 page
- Connection and mounting ▶ 89 page

Ordering types

Breaker types

EBS type (14kA/460V)		
Rated current, I _n	Rated residual current, I _{Δn} : 30mA	
	3-pole	4-pole
15 A	EBS33c/15/30	EBS34c/15/30
20 A	EBS33c/20/30	EBS34c/20/30
30 A	EBS33c/30/30	EBS34c/30/30

EBS type (14kA/460V)		
Rated current, I _n	Rated residual current, I _{Δn} : 100/200/500mA	
	3-pole	4-pole
15 A	EBS33c/15/100	EBS34c/15/100
20 A	EBS33c/20/100	EBS34c/20/100
30 A	EBS33c/30/100	EBS34c/30/100

Accessories

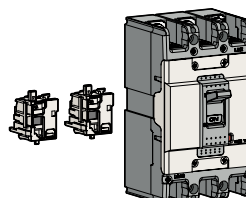

Electrical auxiliaries

AX	Auxiliary Switch
AL	Alarm Switch
AX+AL	Combination switch

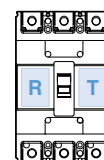

Maximum possibilities

T-position	Not available
R-position	Option of AX or AL or AX+AL

Note) For more detail see 60 page

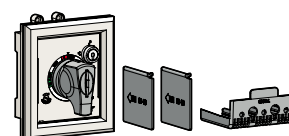
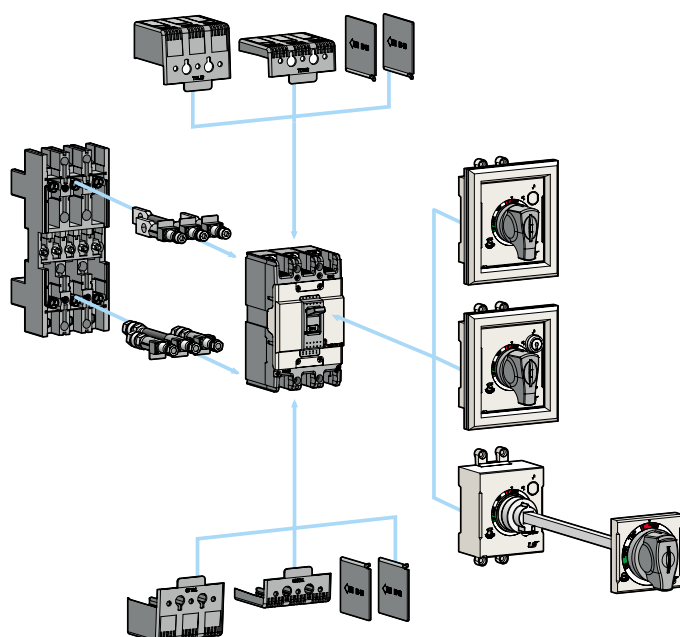

External accessories

EBS30c	Name
IB13	Insulation barrier
TCL13	Terminal cover (Long)
TCS13	Terminal cover (Short)
DH100	Rotary handle (Direct)
DHK100	Rotary handle (Direct, Key lock)
EH100	Rotary handle (Extended)
RTR1	Rear terminal (Round)
PB-A3	Plug-in kit
PHL100	Pad handle lock

Note) For more detail see 65 page

50AF ELCB

EBN50c, EBS50c, EBH50c



EBN53c



EBS53c

Ratings

Frame size		50AF							
Type and Pole		N-Type		S-Type		H-Type			
2-pole(2-sensor)		EBN52c		-		-			
3-pole(3-sensor)		EBN53c		EBS53c		EBH53c			
4-pole(3-sensor)		-		EBS54c		EBH54c			
Rated current, I _n		15-20-30-40-50A							
Rated residual current, I _{Δn}		30, 100/200/500mA (Adjustable)							
Residual current off-time at I _{Δn}		≤0.1 sec							
Rated operational voltage, U _e		AC: 220/460V							
Rated impulse withstand voltage, U _{imp}		6kV							
Wiring system		2-pole(2-sensor)		1 Ø 2W					
		3-pole(3-sensor)		1 Ø 2W, 1 Ø 3W, 3 Ø 3W					
		4-pole(3-sensor)		1 Ø 2W, 1 Ø 3W, 3 Ø 3W, 3 Ø 4W					
Rated short-circuit breaking capacity, I_{cu}		N-Type		S-Type		H-Type			
AC 460V		14kA		18kA		50kA			
IEC 60947-2 (I _{cu})		415V		18kA		50kA			
I _{cs} =100%I _{cu}		220/250V		35kA		100kA			
Protective function		Overload, Short-circuit and Ground fault							
Type of trip unit		Thermal-Magnetic							
Magnetic trip range		12 × I _n (30A and under: 400A)							
Endurance		Mechanical		25000 operations					
		Electrical		10000 operations					
Connection		Standard		Front connection					
		Optional		Rear connection					
				Plug-in					
Mounting		Standard		Screw fixing					
Dimensions (mm)		Pole		2p	3p	3p	4p	3p	4p
		a		50	75	75	100	90	120
		b		130		130		155	
		c1 <small>Note)</small>		60		60		60	
		c2 <small>Note)</small>		64		64		64	
		d		82		82		82	
Weight, kg		Standard		0.5	0.7	0.7	0.9	1	1.2
Certification		Pole		2p	3p	3p	4p	3p	4p
CE marking		CE		○		○		○	

Note) Depth by door cut size : C1 for large cut, C2 for small cut

For more information

- Drawings ▶ 81 page
- Trip curves ▶ 72, 73 page
- Accessories ▶ 60 page
- Connection and mounting ▶ 89 page

Ordering types

Breaker types

EBN type (14kA/460V)				
Rated current, In	Rated residual current, I Δ n: 30mA		Rated residual current, I Δ n: 100/200/500mA	
	2-pole	3-pole	2-pole	3-pole
15 A	EBN52c/15/30	EBN53c/15/30	EBN52c/15/100	EBN53c/15/100
20 A	EBN52c/20/30	EBN53c/20/30	EBN52c/20/100	EBN53c/20/100
30 A	EBN52c/30/30	EBN53c/30/30	EBN52c/30/100	EBN53c/30/100
40 A	EBN52c/40/30	EBN53c/40/30	EBN52c/40/100	EBN53c/40/100
50 A	EBN52c/50/30	EBN53c/50/30	EBN52c/50/100	EBN53c/50/100

EBS type (18kA/460V)				
Rated current, In	Rated residual current, I Δ n: 30mA		Rated residual current, I Δ n: 100/200/500mA	
	3-pole	4-pole	3-pole	4-pole
15 A	EBS53c/15/30	EBS54c/15/30	EBS53c/15/100	EBS54c/15/100
20 A	EBS53c/20/30	EBS54c/20/30	EBS53c/20/100	EBS54c/20/100
30 A	EBS53c/30/30	EBS54c/30/30	EBS53c/30/100	EBS54c/30/100
40 A	EBS53c/40/30	EBS54c/40/30	EBS53c/40/100	EBS54c/40/100
50 A	EBS53c/50/30	EBS54c/50/30	EBS53c/50/100	EBS54c/50/100

EBH type (37kA/460V)				
Rated current, In	Rated residual current, I Δ n: 30mA		Rated residual current, I Δ n: 100/200/500mA	
	3-pole	4-pole	3-pole	4-pole
15 A	EBH53c/15/30	EBH54c/15/30	EBH53c/15/100	EBH54c/15/100
20 A	EBH53c/20/30	EBH54c/20/30	EBH53c/20/100	EBH54c/20/100
30 A	EBH53c/30/30	EBH54c/30/30	EBH53c/30/100	EBH54c/30/100
40 A	EBH53c/40/30	EBH54c/40/30	EBH53c/40/100	EBH54c/40/100
50 A	EBH53c/50/30	EBH54c/50/30	EBH53c/50/100	EBH54c/50/100

Accessories

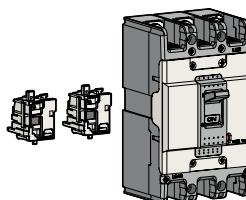

Electrical auxiliaries

AX	Auxiliary Switch
AL	Alarm Switch
AX+AL	Combination switch

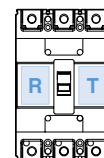

Maximum possibilities

T-position	Not available
R-position	Option of AX or AL or AX+AL

Note) For more detail see 60 page

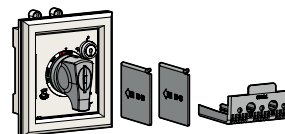

External accessories

EBN50c EBS50c	EBH50c	Name
IB13	IB23	Insulation barrier
TCL13	TCL23	Terminal cover (Long)
TCS13	TCS23	Terminal cover (Short)
DH100	DH125	Rotary handle (Direct)
DHK100	DHK125	Rotary handle (Direct, Key lock)
EH100	EH125	Rotary handle (Extended)
-	RTB2	Rear terminal (Bar)
RTR1	RTR2	Rear terminal (Round)
PB-A3	PB-C3	Plug-in kit
PHL100	PHL125	Pad handle lock

Note) For more detail see 65 page

60AF ELCB

EBN60c, EBS60c



EBN63c



EBS63c

Ratings

Frame size		60AF			
Type and Pole		N-Type	S-Type		
2-pole(2-sensor)		-	-		
3-pole(3-sensor)		EBN63c	EBS63c		
4-pole(3-sensor)		-	EBS64c		
Rated current, I _n		60A			
Rated residual current, I _{Δn}		30, 100/200/500mA (Adjustable)			
Residual current off-time at I _{Δn}		≤0.1 sec			
Rated operational voltage, U _e		AC: 220/460V			
Rated impulse withstand voltage, U _{imp}		6kV			
Wiring system	2-pole(2-sensor)	-			
	3-pole(3-sensor)	1 ∅ 2W, 1 ∅ 3W, 3 ∅ 3W			
	4-pole(3-sensor)	1 ∅ 2W, 1 ∅ 3W, 3 ∅ 3W, 3 ∅ 4W			
Rated short-circuit breaking capacity, I_{cu}		N-Type	S-Type		
AC	460V	14kA	18kA		
IEC 60947-2 (I _{cu})	415V	14kA	18kA		
I _{cs} =100%I _{cu}	220/250V	30kA	35kA		
Protective function		Overload, Short-circuit and Ground fault			
Type of trip unit		Thermal-Magnetic			
Magnetic trip range		12 × I _n			
Endurance	Mechanical	25000 operations			
	Electrical	10000 operations			
Connection	Standard	Front connection			
	Optional	Rear connection			
Mounting	Standard	Plug-in			
		Screw fixing			
Dimensions (mm)		Pole	3p	3p	4p
		a	75	75	100
		b	130	130	130
		c1 <small>Note</small>	60	60	60
		c2 <small>Note</small>	64	64	64
		d	82	82	82
		Weight, kg	Standard	0.7	0.7
Certification		Pole	3p	3p	4p
CE marking		CE	○	○	○

Note) Depth by door cut size : C1 for large cut, C2 for small cut

For more information

- Drawings ▶ 81 page
- Trip curves ▶ 72 page
- Accessories ▶ 60 page
- Connection and mounting ▶ 89 page

Ordering types

Breaker types

EBN type (14kA/460V)			
Rated current, I _n	Rated residual current, I _{Δn} : 30mA		Rated residual current, I _{Δn} : 100/200/500mA
	3-pole		3-pole
60 A	EBS63c/60/30		EBS63c/60/100

EBS type (18kA/460V)				
Rated current, I _n	Rated residual current, I _{Δn} : 30mA		Rated residual current, I _{Δn} : 100/200/500mA	
	3-pole	4-pole	3-pole	4-pole
60 A	EBS63c/60/30	EBS64c/60/30	EBS63c/60/100	EBS64c/60/100

Accessories

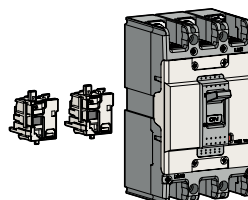

Electrical auxiliaries

AX	Auxiliary Switch
AL	Alarm Switch
AX+AL	Combination switch

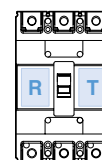

Maximum possibilities

T-position	Not available
R-position	Option of AX or AL or AX+AL

Note) For more detail see 60 page

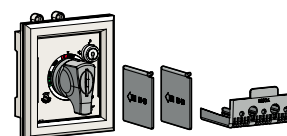
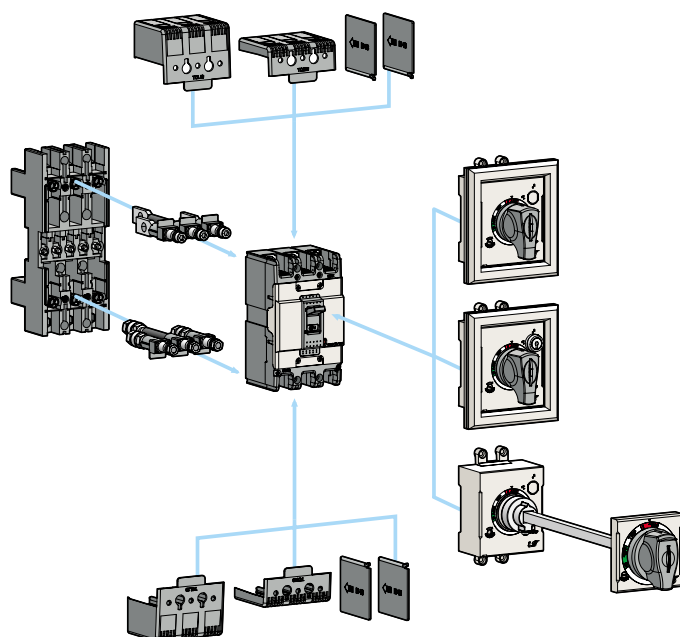

External accessories

EBS60c EBN60c	Name
IB13	Insulation barrier
TCL13	Terminal cover (Long)
TCS13	Terminal cover (Short)
DH100	Rotary handle (Direct)
DHK100	Rotary handle (Direct, Key lock)
EH100	Rotary handle (Extended)
RTB1	Rear terminal (Bar)
RTR1	Rear terminal (Round)
PB-A3	Plug-in kit
PHL100	Pad handle lock

Note) For more detail see 65 page

100AF ELCB

EBN100c

Metasol



EBN103c

Ratings

Frame size		100AF			
Type and Pole		N-Type			
	2-pole(2-sensor)				EBN102c
	3-pole(3-sensor)				EBN103c
	4-pole(3-sensor)				EBN104c
Rated current, I _n		60-75-100A			
Rated residual current, I _{Δn}		30, 100/200/500mA (Adjustable)			
Residual current off-time at I _{Δn}		≤ 0.1 sec			
Rated operational voltage, U _e		AC: 220/460V			
Rated impulse withstand voltage, U _{imp}		6kV			
Wiring system	2-pole(2-sensor)				1 ∅ 2W
	3-pole(3-sensor)				1 ∅ 2W, 1 ∅ 3W, 3 ∅ 3W
	4-pole(3-sensor)				1 ∅ 2W, 1 ∅ 3W, 3 ∅ 3W, 3 ∅ 4W
Rated short-circuit breaking capacity, I_{cu}		N-Type			
	AC 460V				18kA
	IEC 60947-2 (I _{cu}) 415V				18kA
	I _{cs} =100%I _{cu} 220/250V				35kA
Protective function		Overload, Short-circuit and Ground fault			
Type of trip unit		Thermal-Magnetic			
Magnetic trip range		12 × I _n			
Endurance	Mechanical	25000 operations			
	Electrical	10000 operations			
Connection	Standard	Front connection			
	Optional	Rear connection			
Mounting		Plug-in			
	Standard	Screw fixing			
Dimensions (mm)		Pole	2p	3p	4p
	a		50	75	100
	b		130	130	130
	c1 <small>Note)</small>		60	60	60
	c2 <small>Note)</small>		64	64	64
	d		82	82	82
	Weight, kg	Standard	0.5	0.7	0.9
Certification		Pole	2p	3p	4p
CE marking		CE	○	○	○

Note) Depth by door cut size : c1 for large cut, c2 for small cut

For more information

- Drawings ▶ 81 page
- Trip curves ▶ 72 page
- Accessories ▶ 60 page
- Connection and mounting ▶ 89 page

Ordering types

Breaker types

EBN type (18kA/460V)			
Rated current, I _n	Rated residual current, I _{Δn} : 30mA		
	2-pole	3-pole	4-pole
60 A	EBN102c/60/30	EBN103c/60/30	EBN104c/60/30
75 A	EBN102c/75/30	EBN103c/75/30	EBN104c/75/30
100 A	EBN102c/100/30	EBN103c/100/30	EBN104c/100/30

Rated current, I _n	Rated residual current, I _{Δn} : 100/200/500mA		
	2-pole	3-pole	4-pole
60 A	EBN102c/60/100	EBN103c/60/100	EBN104c/60/100
75 A	EBN102c/75/100	EBN103c/75/100	EBN104c/75/100
100 A	EBN102c/100/100	EBN103c/100/100	EBN104c/100/100

Accessories

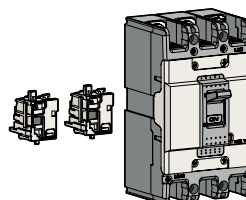

Electrical auxiliaries

AX	Auxiliary Switch
AL	Alarm Switch
AX+AL	Combination switch

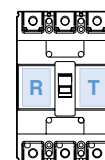

Maximum possibilities

T-position	Not available
R-position	Option of AX or AL or AX+AL

Note) For more detail see 60 page

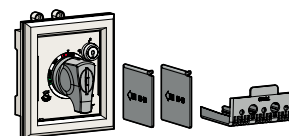
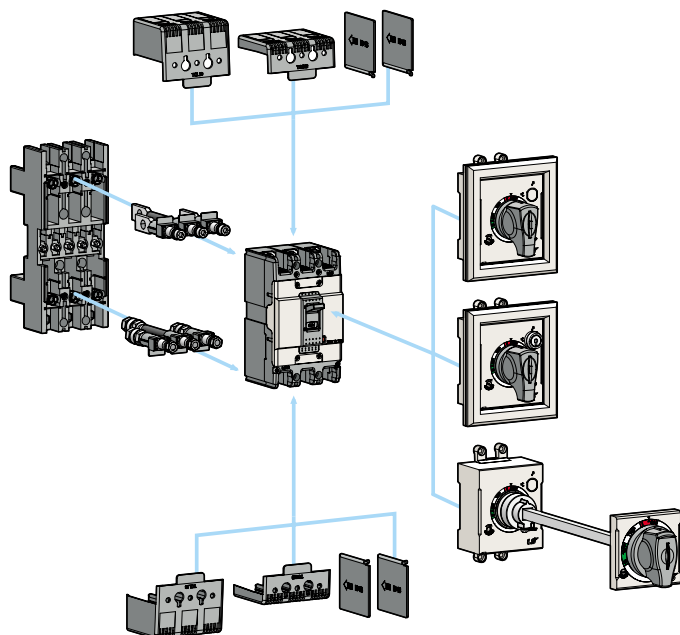

External accessories

EBN100c	Name
IB13	Insulation barrier
TCL13	Terminal cover (Long)
TCS13	Terminal cover (Short)
DH100	Rotary handle (Direct)
DHK100	Rotary handle (Direct, Key lock)
EH100	Rotary handle (Extended)
RTB1	Rear terminal (Bar)
RTR1	Rear terminal (Round)
PB-A3	Plug-in kit
PHL100	Pad handle lock

Note) For more detail see 65 page

125AF ELCB

EBS125c, EBH125c



EBS103c



EBH103c

Ratings

Frame size		125AF				
Type and Pole		S-Type		H-Type		
2-pole(2-sensor)		-		-		
3-pole(3-sensor)		EBS103c		EBH103c		
4-pole(3-sensor)		EBS104c		EBH104c		
Rated current, I _n		15-20-30-40-50-60-75-100-125A				
Rated residual current, I _{Δn}		30, 100/200/500mA (Adjustable)				
Residual current off-time at I _{Δn}		≤ 0.1 sec				
Rated operational voltage, U _e		AC: 220/460V				
Rated impulse withstand voltage, U _{imp}		6kV				
Wiring system		2-pole(2-sensor)		-		
		3-pole(3-sensor)		1 ∅ 2W, 1 ∅ 3W, 3 ∅ 3W		
		4-pole(3-sensor)		1 ∅ 2W, 1 ∅ 3W, 3 ∅ 3W, 3 ∅ 4W		
Rated short-circuit breaking capacity, I_{cu}		S-Type		H-Type		
AC 460V		37kA		50kA		
IEC 60947-2 (I _{cu}) 415V		37kA		50kA		
I _{cs} =100%I _{cu} 220/250V		85kA		100kA		
Protective function		Overload, Short-circuit and Ground fault				
Type of trip unit		Thermal-Magnetic				
Magnetic trip range		12 × I _n (30A and under: 400A)				
Endurance		Mechanical		25000 operations		
		Electrical		10000 operations		
Connection		Standard		Front connection		
		Optional		Rear connection		
		Plug-in				
Mounting		Standard		Screw fixing		
Dimensions (mm)		Pole	3p	4p	3p	4p
		a	90	120	90	120
		b	155	155	155	155
		c1 <small>Note)</small>	60	60	60	60
		c2 <small>Note)</small>	64	64	64	64
		d	82	82	82	82
		Weight, kg	Standard	1	1.2	1
Certification		Pole	3p	4p	3p	4p
CE marking		CE	○	○	○	○

Note) Depth by door cut size : c1 for large cut, c2 for small cut

For more information

- Drawings ▶ 82 page
- Trip curves ▶ 73 page
- Accessories ▶ 60 page
- Connection and mounting ▶ 89 page

Ordering types

Breaker types

EBS type (37kA/460V)				
Rated current, I _n	Rated residual current, I _{Δn} : 30mA		Rated residual current, I _{Δn} : 100/200/500mA	
	3-pole	4-pole	3-pole	4-pole
15 A	EBS103c/15/30	EBS104c/15/30	EBS103c/15/100	EBS104c/15/100
20 A	EBS103c/20/30	EBS104c/20/30	EBS103c/20/100	EBS104c/20/100
30 A	EBS103c/30/30	EBS104c/30/30	EBS103c/30/100	EBS104c/30/100
40 A	EBS103c/40/30	EBS104c/40/30	EBS103c/40/100	EBS104c/40/100
50 A	EBS103c/50/30	EBS104c/50/30	EBS103c/50/100	EBS104c/50/100
60 A	EBS103c/60/30	EBS104c/60/30	EBS103c/60/100	EBS104c/60/100
75 A	EBS103c/75/30	EBS104c/75/30	EBS103c/75/100	EBS104c/75/100
100 A	EBS103c/100/30	EBS104c/100/30	EBS103c/100/100	EBS104c/100/100
125 A	EBS103c/125/30	EBS104c/125/30	EBS103c/125/100	EBS104c/125/100

EBH type (50kA/460V)				
Rated current, I _n	Rated residual current, I _{Δn} : 30mA		Rated residual current, I _{Δn} : 100/200/500mA	
	3-pole	4-pole	3-pole	4-pole
15 A	EBH103c/15/30	EBH104c/15/30	EBH103c/15/100	EBH104c/15/100
20 A	EBH103c/20/30	EBH104c/20/30	EBH103c/20/100	EBH104c/20/100
30 A	EBH103c/30/30	EBH104c/30/30	EBH103c/30/100	EBH104c/30/100
40 A	EBH103c/40/30	EBH104c/40/30	EBH103c/40/100	EBH104c/40/100
50 A	EBH103c/50/30	EBH104c/50/30	EBH103c/50/100	EBH104c/50/100
60 A	EBH103c/60/30	EBH104c/60/30	EBH103c/60/100	EBH104c/60/100
75 A	EBH103c/75/30	EBH104c/75/30	EBH103c/75/100	EBH104c/75/100
100 A	EBH103c/100/30	EBH104c/100/30	EBH103c/100/100	EBH104c/100/100
125 A	EBH103c/125/30	EBH104c/125/30	EBH103c/125/100	EBH104c/125/100

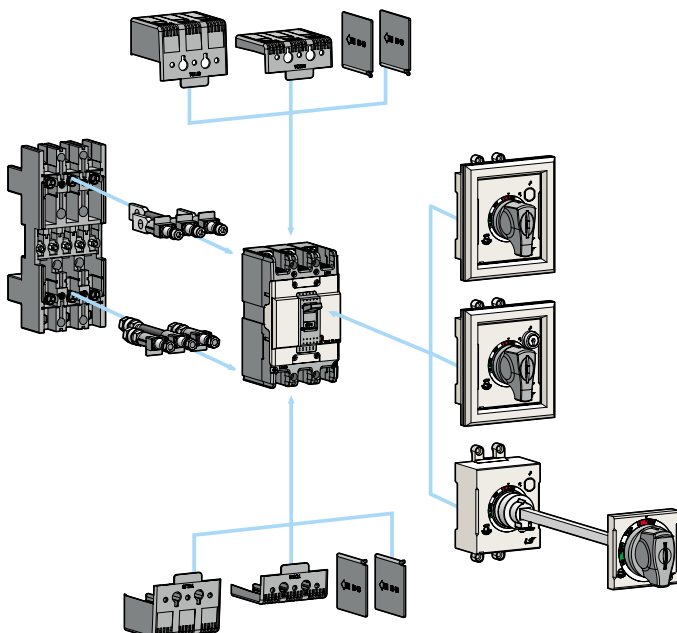

Accessories

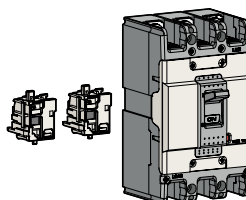

Electrical auxiliaries

AX	Auxiliary Switch
AL	Alarm Switch
AX+AL	Combination switch

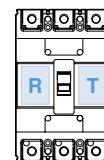

Maximum possibilities

T-position	Not available
R-position	Option of AX or AL or AX+AL

Note) For more detail see 60 page

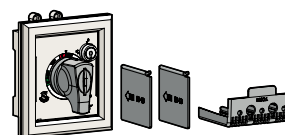

External accessories

EBS125c EBH125c	Name
IB23	Insulation barrier
TCL23	Terminal cover (Long)
TCS23	Terminal cover (Short)
DH125	Rotary handle (Direct)
DHK125	Rotary handle (Direct, Key lock)
EH125	Rotary handle (Extended)
RTB2	Rear terminal (Bar)
RTR2	Rear terminal (Round)
PB-C3	Plug-in kit
PHL125	Pad handle lock

Note) For more detail see 65 page

250AF ELCB

EBN250c, EBS250c, EBH250c



EBN203c



EBS203c

Ratings

Frame size		250AF													
Type and Pole		N-Type		S-Type		H-Type									
2-pole(2-sensor)		EBN202c		-		-									
3-pole(3-sensor)		EBN203c		EBS203c		EBH203c									
4-pole(3-sensor)		-		EBS204c		EBH204c									
Rated current, I _n		100-125-150-175-200-225-250A													
Rated residual current, I _{Δn}		30, 100/200/500mA (Adjustable)													
Residual current off-time at I _{Δn}		≤ 0.1 sec													
Rated operational voltage, U _e		AC: 220/460V													
Rated impulse withstand voltage, U _{imp}		6kV													
Wiring system		2-pole(2-sensor)		1 ∅ 2W											
		3-pole(3-sensor)		1 ∅ 2W, 1 ∅ 3W, 3 ∅ 3W											
		4-pole(3-sensor)		1 ∅ 2W, 1 ∅ 3W, 3 ∅ 3W, 3 ∅ 4W											
Rated short-circuit breaking capacity, I_{cu}		N-Type		S-Type		H-Type									
AC 460V		26kA		37kA		50kA									
IEC 60947-2 (I _{cu})		415V		37kA		50kA									
I _{cs} =100%I _{cu}		220/250V		85kA		100kA									
Protective function		Overload, Short-circuit and Ground fault													
Type of trip unit		Thermal-Magnetic													
Magnetic trip range		12 × I _n													
Endurance		Mechanical		20000 operations											
		Electrical		5000 operations											
Connection		Standard		Front connection											
		Optional		Rear connection											
				Plug-in											
Mounting		Standard		Screw fixing											
Dimensions (mm)		Pole		2p		3p		3p		4p		3p		4p	
		a		105		105		105		140		105		140	
		b		165		165		165		165		165		165	
		c1 <small>Note</small>		60		60		60		60		60		60	
		c2 <small>Note</small>		64		64		64		64		64		64	
		d		87		87		87		87		87		87	
Weight, kg		Standard		1.1		1.2		1.2		1.5		1.2		1.5	
Certification		Pole		2p		3p		3p		4p		3p		4p	
CE marking		CE		○		○		○		○		○		○	

Note) Depth by door cut size : c1 for large cut, c2 for small cut

For more information

- Drawings ▶ 83 page
- Trip curves ▶ 74 page
- Accessories ▶ 60 page
- Connection and mounting ▶ 89 page

Ordering types

Breaker types

EBN type (25kA/460V)				
Rated current, In	Rated residual current, I Δ n: 30mA		Rated residual current, I Δ n: 100/200/500mA	
	2-pole	3-pole	2-pole	3-pole
100 A	EBN202c/100/30	EBN203c/100/30	EBN202c/100/100	EBN203c/100/100
125 A	EBN202c/125/30	EBN203c/125/30	EBN202c/125/100	EBN203c/125/100
150 A	EBN202c/150/30	EBN203c/150/30	EBN202c/150/100	EBN203c/150/100
175 A	EBN202c/175/30	EBN203c/175/30	EBN202c/175/100	EBN203c/175/100
200 A	EBN202c/200/30	EBN203c/200/30	EBN202c/200/100	EBN203c/200/100
225 A	EBN202c/225/30	EBN203c/225/30	EBN202c/225/100	EBN203c/225/100
250 A	EBN202c/250/30	EBN203c/250/30	EBN202c/250/100	EBN203c/250/100

EBS type (37kA/460V)				
Rated current, In	Rated residual current, I Δ n: 30mA		Rated residual current, I Δ n: 100/200/500mA	
	3-pole	4-pole	3-pole	4-pole
100 A	EBS203c/100/30	EBS204c/100/30	EBS203c/100/100	EBS204c/100/100
125 A	EBS203c/125/30	EBS204c/125/30	EBS203c/125/100	EBS204c/125/100
150 A	EBS203c/150/30	EBS204c/150/30	EBS203c/150/100	EBS204c/150/100
175 A	EBS203c/175/30	EBS204c/175/30	EBS203c/175/100	EBS204c/175/100
200 A	EBS203c/200/30	EBS204c/200/30	EBS203c/200/100	EBS204c/200/100
225 A	EBS203c/225/30	EBS204c/225/30	EBS203c/225/100	EBS204c/225/100
250 A	EBS203c/250/30	EBS204c/250/30	EBS203c/250/100	EBS204c/250/100

EBH type (50kA/460V)				
Rated current, In	Rated residual current, I Δ n: 30mA		Rated residual current, I Δ n: 100/200/500mA	
	3-pole	4-pole	3-pole	4-pole
100 A	EBH203c/100/30	EBH204c/100/30	EBH203c/100/100	EBH204c/100/100
125 A	EBH203c/125/30	EBH204c/125/30	EBH203c/125/100	EBH204c/125/100
150 A	EBH203c/150/30	EBH204c/150/30	EBH203c/150/100	EBH204c/150/100
175 A	EBH203c/175/30	EBH204c/175/30	EBH203c/175/100	EBH204c/175/100
200 A	EBH203c/200/30	EBH204c/200/30	EBH203c/200/100	EBH204c/200/100
225 A	EBH203c/225/30	EBH204c/225/30	EBH203c/225/100	EBH204c/225/100
250 A	EBH203c/250/30	EBH204c/250/30	EBH203c/250/100	EBH204c/250/100

Accessories

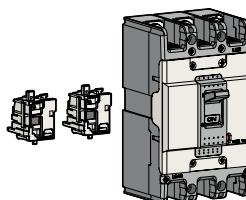

Electrical auxiliaries

AX	Auxiliary Switch
AL	Alarm Switch
AX+AL	Combination switch

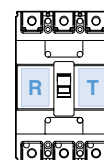

Maximum possibilities

T-position	Not available
R-position	Option of AX or AL or AX+AL

Note) For more detail see 60 page

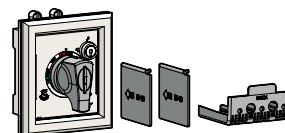

External accessories

EBN250c EBS250c EBH250c	Name
IB23	Insulation barrier
TCL33	Terminal cover (Long)
TCS33	Terminal cover (Short)
DH250	Rotary handle (Direct)
DHK250	Rotary handle (Direct, Key lock)
EH250	Rotary handle (Extended)
RTB3	Rear terminal (Bar)
RTR3	Rear terminal (Round)
PB-D3	Plug-in kit
PHL250	Pad handle lock

Note) For more detail see 65 page

400AF ELCB

EBN400c, EBS400c, EBH400c, EBL400c



EBS403c



EBL404c

Ratings

Frame size		400AF								
Type and Pole		N-Type		S-Type		H-Type		L-Type		
	3-pole(3-sensor)	EBN403c		EBS403c		EBH403c		EBL403c		
	4-pole(3-sensor)	EBN404c		EBS404c		EBH404c		EBL404c		
Rated current, I _n		250-300-350-400A								
Rated residual current, I _{Δn}		30, 100/200/500mA (Adjustable)								
Residual current off-time at I _{Δn}		≤0.1 sec								
Rated operational voltage, U _e		220/460V								
Rated impulse withstand voltage, U _{imp}		6kV								
Wiring system	3-pole(3-sensor)	1 ∅ 2W, 1 ∅ 3W, 3 ∅ 3W								
	4-pole(3-sensor)	1 ∅ 2W, 1 ∅ 3W, 3 ∅ 3W, 3 ∅ 4W								
Rated short-circuit breaking capacity, I _{cu}		N-Type		S-Type		H-Type		L-Type		
AC		415/460V		37kA		50kA		65kA		
IEC 60947-2 (I _{cu})		220/250V		50kA		75kA		85kA		
I _{cs} =%I _{cu}		100%		100%		100%		75%		
Protective function		Overload, Short-circuit and Ground fault								
Type of trip unit		Thermal-Magnetic								
Magnetic trip range		8~12I _n								
Endurance	Mechanical	4000 operations								
	Electrical	1000 operations								
Connection	Standard	Front connection								
	Optional	Rear connection								
Mounting		Screw fixing								
Dimensions (mm)		Pole	3p	4p	3p	4p	3p	4p	3p	4p
		a	104	184	104	184	104	184	104	184
		b	257		257		257		257	
		c1 <small>Note)</small>	109		109		109		109	
		c2 <small>Note)</small>	113		113		113		113	
		d	145		145		145		145	
		d	145		145		145		145	
Weight, kg		Standard	7	8.4	7	8.4	7	8.4	7	7
Certification		Pole	3p	4p	3p	4p	3p	4p	3p	3p
CE marking		CE	-	-	-	-	-	-	-	-

Note) Depth by door cut size : c1 for large cut, c2 for small cut

For more information

- Drawings ▶ 84 page
- Trip curves ▶ 75 page
- Accessories ▶ 61 page
- Connection and mounting ▶ 90 page

Ordering types

Breaker types

EBN type (25kA/460V)				
Rated current, In	Rated residual current, I Δ n: 30mA		Rated residual current, I Δ n: 100/200/500mA	
	3-pole	4-pole	3-pole	4-pole
250 A	EBN403c/250/30	EBN404c/250/30	EBN403c/250/100	EBN404c/250/100
300 A	EBN403c/300/30	EBN404c/300/30	EBN403c/300/100	EBN404c/300/100
350 A	EBN403c/350/30	EBN404c/350/30	EBN403c/350/100	EBN404c/350/100
400 A	EBN403c/400/30	EBN404c/400/30	EBN403c/400/100	EBN404c/400/100

EBS type (50kA/460V)				
Rated current, In	Rated residual current, I Δ n: 30mA		Rated residual current, I Δ n: 100/200/500mA	
	3-pole	4-pole	3-pole	4-pole
250 A	EBS403c/250/30	EBS404c/250/30	EBS403c/250/100	EBS404c/250/100
300 A	EBS403c/300/30	EBS404c/300/30	EBS403c/300/100	EBS404c/300/100
350 A	EBS403c/350/30	EBS404c/350/30	EBS403c/350/100	EBS404c/350/100
400 A	EBS403c/400/30	EBS404c/400/30	EBS403c/400/100	EBS404c/400/100

EBH type(65kA/460V)				
Rated current, In	Rated residual current, I Δ n: 30mA		Rated residual current, I Δ n: 100/200/500mA	
	3-pole	4-pole	3-pole	4-pole
250 A	EBH403c/250/30	EBH404c/250/30	EBH403c/250/100	EBH404c/250/100
300 A	EBH403c/300/30	EBH404c/300/30	EBH403c/300/100	EBH404c/300/100
350 A	EBH403c/350/30	EBH404c/350/30	EBH403c/350/100	EBH404c/350/100
400 A	EBH403c/400/30	EBH404c/400/30	EBH403c/400/100	EBH404c/400/100

EBL type(85kA/460V)				
Rated current, In	Rated residual current, I Δ n: 30mA		Rated residual current, I Δ n: 100/200/500mA	
	3-pole	4-pole	3-pole	4-pole
250 A	EBL403c/250/30	EBL404c/250/30	EBL403c/250/100	EBL404c/250/100
300 A	EBL403c/300/30	EBL404c/300/30	EBL403c/300/100	EBL404c/300/100
350 A	EBL403c/350/30	EBL404c/350/30	EBL403c/350/100	EBL404c/350/100
400 A	EBL403c/400/30	EBL404c/400/30	EBL403c/400/100	EBL404c/400/100

Accessories



Electrical auxiliaries

AX	Auxiliary Switch
AL	Alarm Switch
SHT	Shunt Trip
UVT	Undervoltage trip

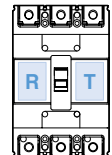

Maximum possibilities

T-position	Not available
R-position	Option of 2AX, 2AL and SHT or UVT

Note) For more detail see 61 page

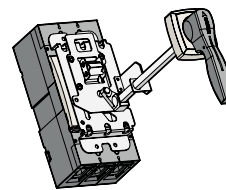

E-70U

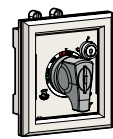

N-70

External accessories

IBL400	Insulation barrier
T1-43A	Terminal cover (Long) - 2, 3pole
T1-44A	Terminal cover (Long) - 4pole
N-70	Rotary handle (Direct)
E-70U	Rotary handle (Extended)
MI-43	Mechanical interlock - 2, 3pole
MI-44	Mechanical interlock - 4pole
X-402	Rear terminal - 2pole
X-403	Rear terminal - 3pole
X-404	Rear terminal - 4pole
PB-I3-FR	Plug-in kit

Note) For more detail see 65 page

800AF ELCB

EBN803c, EBS803c, EBL803c



EBS803c

Ratings

Frame size		800AF		
Type and Pole	3-pole(3-sensor)	N-Type	S-Type	L-Type
	4-pole(3-sensor)	EBN803c	EBS803c	EBL803c
		-	-	-
Rated current, I _n		500-630-700-800A		
Rated residual current, I _{Δn}		30, 100/200/500mA (Adjustable)		
Residual current off-time at I _{Δn}		≤0.1 sec		
Rated operational voltage, U _e		220/460V		
Rated impulse withstand voltage, U _{imp}		6 kV		
Wiring system	3-pole(3-sensor)	1 ∅ 2W, 1 ∅ 3W, 3 ∅ 3W		
	4-pole(3-sensor)	-		
Rated short-circuit breaking capacity, I_{cu}		N-Type	S-Type	L-Type
AC	415/460V	37kA	65kA	85kA
IEC 60947-2 (I _{cu})	220/250V	50kA	85kA	125kA
I _{cs} =%I _{cu}		100%	100%	75%
Protective function		Overload, Short-circuit and Ground fault		
Type of trip unit		Thermal-Magnetic		
Magnetic trip range		8~12I _n		
Endurance	Mechanical	2500 operations		
	Electrical	500 operations		
Connection	Standard	Front connection		
	Optional	Rear connection		
		Plug-in		
Mounting	Standard	Screw fixing		
Dimensions (mm)		Pole	3p	
	a		210	
	b		280	
	c1 <small>Note)</small>		109	
	c2 <small>Note)</small>		113	
	d		145	
	Weight, kg	Standard		
Certification		Pole	3p	
CE marking		-		

Note) Depth by door cut size : c1 for large cut, c2 for small cut

For more information

- Drawings ▶ 85 page
- Trip curves ▶ 75 page
- Accessories ▶ 61 page
- Connection and mounting ▶ 90 page

Ordering types

Breaker types

EBN type (37kA/460V)		
Rated current, I _n	Rated residual current, I _{Δn} : 30mA	Rated residual current, I _{Δn} : 100/200/500mA
	3p	3p
500 A	EBN803c/500/30	EBN803c/500/100
630 A	EBN803c/630/30	EBN803c/630/100
700 A	EBN803c/700/30	EBN803c/700/100
800 A	EBN803c/800/30	EBN803c/800/100

EBS type (65kA/460V)		
Rated current, I _n	Rated residual current, I _{Δn} : 30mA	Rated residual current, I _{Δn} : 100/200/500mA
	3p	3p
500 A	EBS803c/500/30	EBS803c/500/100
630 A	EBS803c/630/30	EBS803c/630/100
700 A	EBS803c/700/30	EBS803c/700/100
800 A	EBS803c/800/30	EBS803c/800/100

EBL type(85kA/460V)		
Rated current, I _n	Rated residual current, I _{Δn} : 30mA	Rated residual current, I _{Δn} : 100/200/500mA
	3p	3p
500 A	EBL803c/500/30	EBL803c/500/100
630 A	EBL803c/630/30	EBL803c/630/100
700 A	EBL803c/700/30	EBL803c/700/100
800 A	EBL803c/800/30	EBL803c/800/100

Accessories

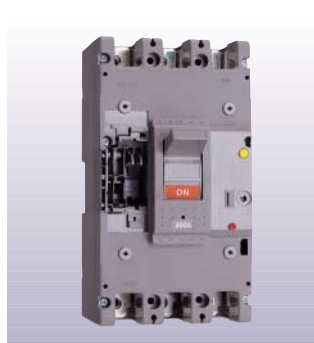

Electrical auxiliaries

AX	Auxiliary Switch
AL	Alarm Switch
SHT	Shunt Trip
UVT	Undervoltage trip

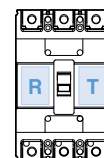

Maximum possibilities

T-position	Not available
R-position	Option of 2AX, 2AL and SHT or UVT

Note) For more detail see 61 page

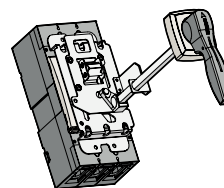

E-80U

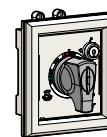

N-80

External accessories

IBL800	Insulation barrier
T1-63A	Terminal cover (Long) - 2, 3pole
T1-64A	Terminal cover (Long) - 4pole
N-80	Rotary handle (Direct)
E-80U	Rotary handle (Extended)
MI-83S	Mechanical interlock - 2, 3pole
MI-84S	Mechanical interlock - 4pole
X-802	Rear terminal - 2pole
X-803	Rear terminal - 3pole
X-804	Rear terminal - 4pole
PB-J3-FR	Plug-in kit

Note) For more detail see 65 page

Electrical auxiliaries of 30~250AF

Option of connecting AX or AL or AX+AL
This seat is not available for 2-pole breakers.

Option of connecting SHT or UVT or AX or AL or AX+AL
This seat is not available for ELCB.

Maximum possibilities

Position	Type	ABN100c		ABH125c		ABH250c	EBN100c	EBH125c	EBH250c
		2p	3/4p	2p	3/4p	2/3/4p	2/3/4p	3/4p	2/3/4p
Left-hand seat	AX	-	1	-	1	1	1	1	1
	AL	-	1	-	1	1	1	1	1
	AX+AL	-	1	-	1	1	1	1	1
Right-hand seat	AX	1	1	1	1	1	-	-	-
	AL	1	1	1	1	1	-	-	-
	AX+AL	1	1	1	1	1	-	-	-
	SHT/UVT	1	1	1	1	1	-	-	-

Electrical auxiliaries of 400~800AF

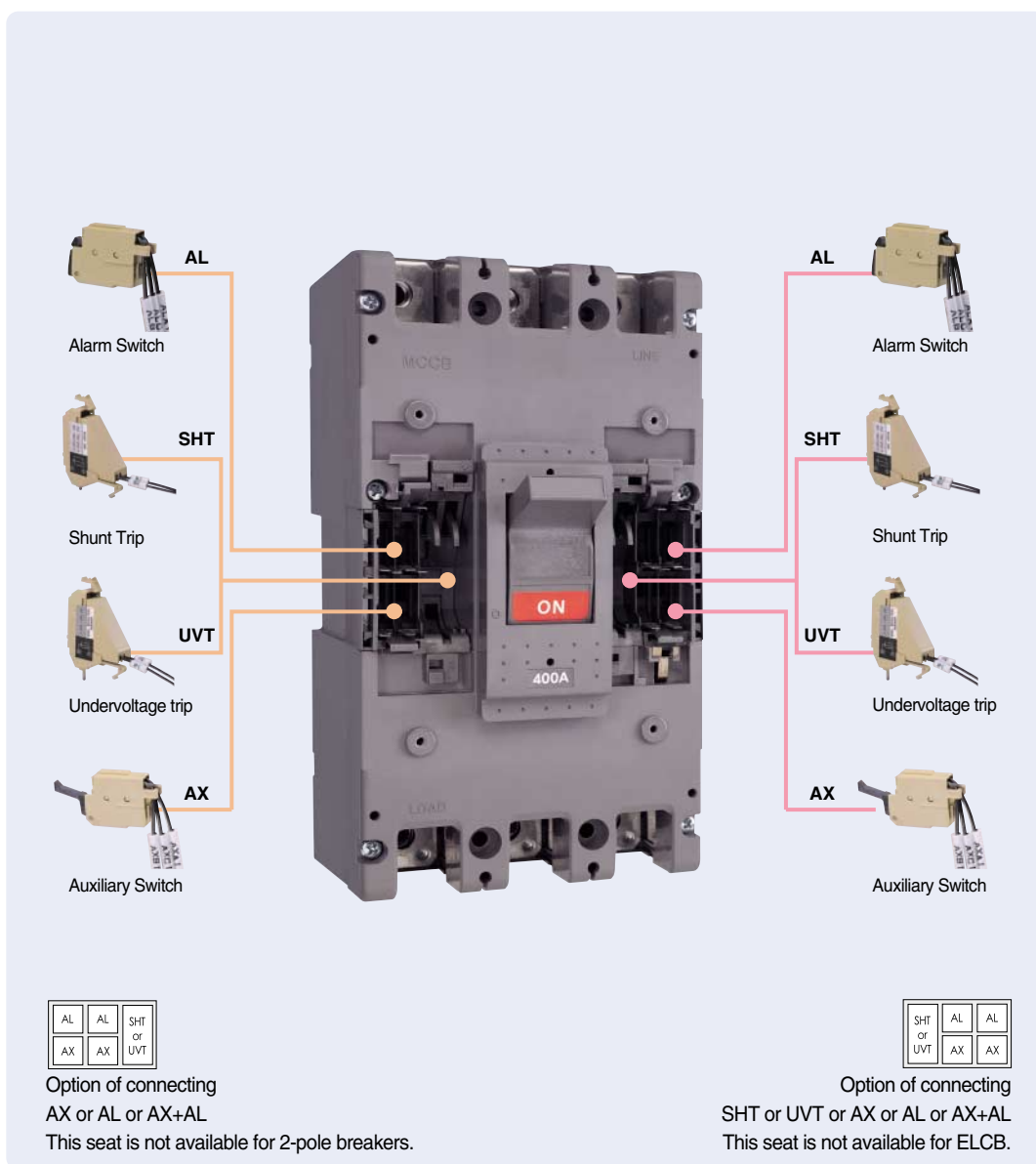

Maximum possibilities

Position	Type	MCCB (400~800AF)	ELCB (400~800AF)
Left-hand seat	AX	2	2
	AL	2	2
	SHT/UVT	1	1
Right-hand seat	AX	2	-
	AL	2	-
	SHT/UVT	1	-

Auxiliary and Alarm switch

Auxiliary switch (AX)



Auxiliary switch is for applications requiring remote “ON” and “OFF” indication. Each switch contains two contacts having a common connection. One is open and the other closed when the circuit breaker is open, and viceversa.

Alarm switch (AL)



Alarm switches offer provisions for immediate audio or visual indication of a tripped breaker due to overload, short circuit, shunt trip, or undervoltage release conditions. They are particularly useful in automated plants where operators must be signaled about changes in the electrical distribution system. This switch features a closed contact when the circuit breaker is tripped automatically. In other words, this switch does not function when the breaker is operated manually. Its contact is open when the circuit breaker is reset.

Combination switch (AX+AL)

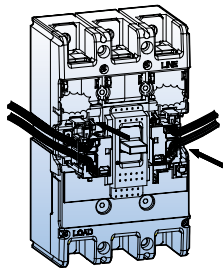

It consists of one auxiliary switch (AX) and one alarm switch (AL) in a body to connect into the same position of the breaker.

Contact (AX+AL)

MCCB	ON	OFF	TRIP
AX			
AL			

Rating (AX+AL)

Conventional thermal current, I _{th}	5A		
Rated operational current, I _e	Voltage, U _e	Current, I _e	
		Resistive load	Inductive load
AC 50/60Hz	125V	5	3
	250V	3	2
	500V	-	-
DC	30V	4	3
	125V	0.4	0.4
	250V	0.2	0.2

Shunt trip, SHT

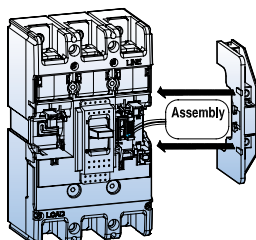

The shunt trip opens the mechanism in response to an externally applied voltage signal. The releases include coil clearing contacts that automatically clear the signal circuit when the breaker has tripped. This is not available for ELCBs of 30~250AF .

Rating for 30~250AF



Control voltage, Ue	Power consumption		
	AC (VA)	DC (W)	mA
AC/DC 12V	0.35	0.36	30
AC/DC 24V	0.64	0.65	27
AC/DC 48V	1.09	1.1	23
AC/DC 60V	1.2	1.22	20
AC/DC 100~130V	0.73	0.75	5.8
AC/DC 200~250V	1.21	1.35	5.4
AC 380~450V	1.67	-	3.8
AC 440~500V	1.68	-	3.5
Max. opening time	50ms (max.)		
Tightening torque of terminal screw	8.2 kgf · cm		

Note:

- Range of operational voltage: 0.7 ~ 1.1Vn
- Frequency (Only AC): 45Hz ~ 65Hz

Rating for 400~800AF



Control voltage, Ue	Power consumption		
	V	mA	W
AC/DC 24~48	AC 24	14	0.3
AC 100~125/DC 100~110	DC 24	15.4	0.4
AC 200~240/DC 200~220	AC 48	14	0.7
AC 380~460	DC 48	16	0.8
AC 480~550	AC 110	6	0.7
	DC 110	6.6	0.7
	AC 220	6.8	1.5
	DC 200	7.6	1.5
	AC 440	4.3	1.9
	AC 480	4.4	3.3
	AC 550	4.6	2.4

Note: Range of operational voltage

- AC: 0.85 ~ 1.1Vn
- DC: 0.75 ~ 1.25Vn

Undervoltage release, UVT

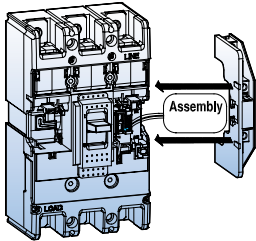

The undervoltage release automatically opens a circuit breaker when voltage drops to a value ranging between 20% to 70% of the line voltage. The operation is instantaneous, and after tripping, the circuit breaker cannot be re-closed again until the voltage returns to 85% of line voltage.

Continuously energized, the undervoltage release must be operating before the circuit breaker can be closed. This is not available for ELCBs of 30~250AF .

- Range of tripping voltage: 0.2 ~ 0.7Vn
- Reset and closing of a breaker is possible when the control voltage is over 0.85Vn
- Frequency (Only AC): 45Hz ~ 65Hz

Rating for 30~250AF



Control voltage, Ue	Power consumption		
	AC (VA)	DC (W)	mA
AC/DC 24V	0.64	0.65	27
AC/DC 48V	1.09	1.1	23
AC/DC 100~110V	0.73	0.75	5.8
AC/DC 200~220V	1.21	1.35	5.4
AC 380~440V	1.67	-	3.8
AC 440~480V	1.68	-	3.5
Max. opening time		50ms (max.)	
Tightening torque of terminal screw		8.2 kgf · cm	
Operating voltage range	Trip	20~70% Vn	
	Reset/Closing	≥ 0.85Vn	

Rating for 400~800AF



Control voltage, Ue	Trip voltage	Reset/closing voltage	Time rating
AC/DC 48	· AC: 85~1.1Vn · DC: 85~1.25Vn	· AC: 0.2~0.7Vn · DC: 0.2~0.7Vn	Continuous
AC/DC 100~125			
AC/DC 200~240			
AC 380~440			
AC 440~480			

Terminal numbering

Auxiliary Switch (AX)	Alarm Switch (AL)	Shunt Trip (SHT)	Undervoltage trip (UVT)

External accessories

Wide range of external accessories provides user-friendly solution for mounting, cable connection, insulation, safety lock and remote control.

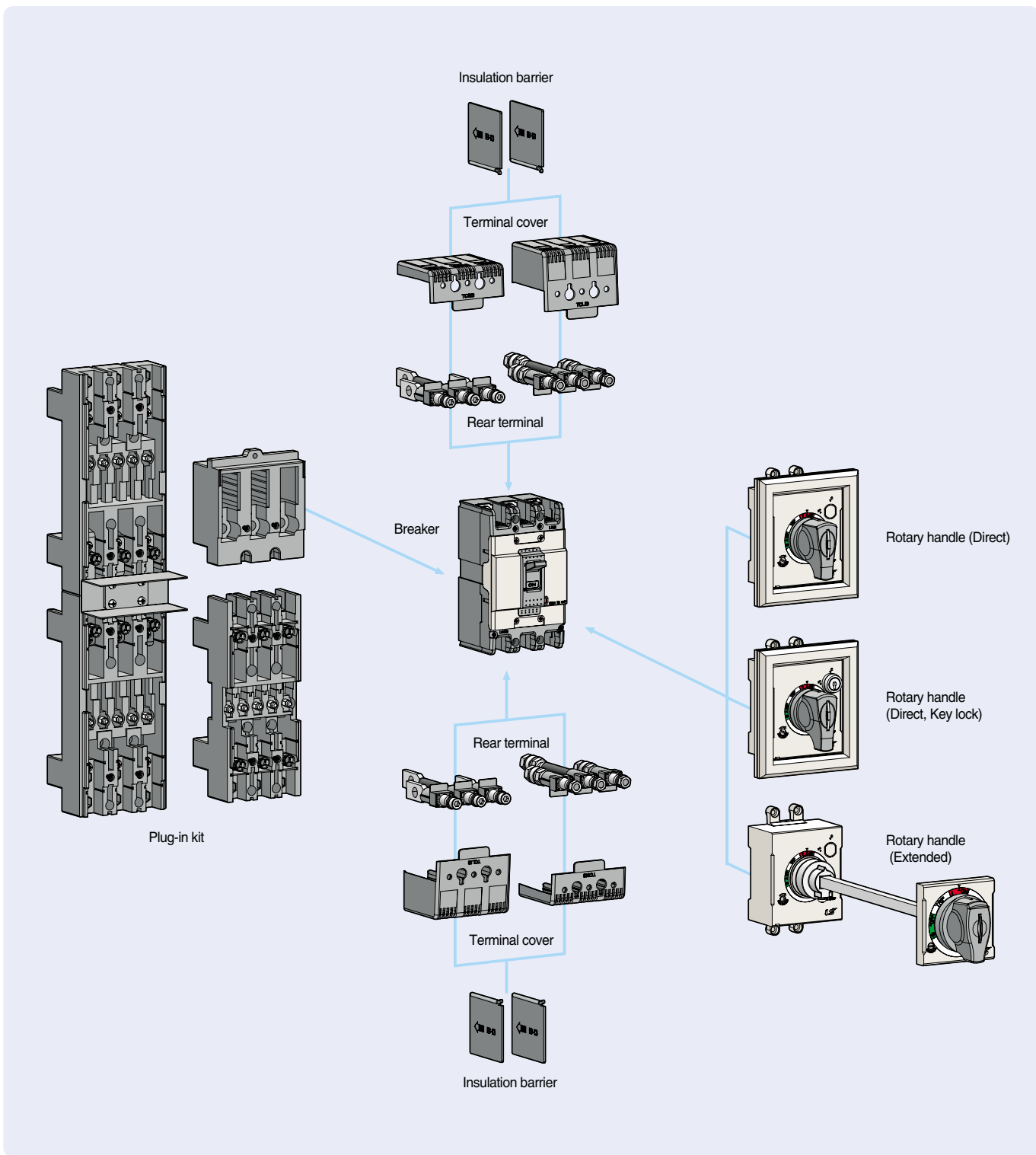

Rotary handles

The rotary handle operating mechanism is available in either the direct version or in the extended version on the compartment door. It is always fitted with a compartment door lock and on a request it can be supplied with a key lock in the open position.



Direct type



Direct type
(with a key lock)

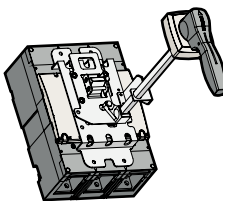

E-80U



Extended type

Type

Direct type	Direct type (Key lock)	Extended type	Breaker type	
			MCCB	ELCB
DH100	DHK100	EH100	ABN50c/60c/100c ABS30c/50c/60c	EBN50c/60c/100c EBS30c/50c/60c
DH125	DHK125	EH125	ABS125c ABH50c/125c	EBS125c EBH50c/125c
DH250	DHK250	EH250	ABN250c, ABS250c ABH250c	EBN250c, EBS250c EBH250c
N-70	-	E-70U	ABN/S/H/L400c	EBN/S/H/L400c
N-80	-	E-80U	ABN/S/L800c	EBN/S/L800c

Degree of protections

Type	Degree of protection	IP degree
Circuit breaker with cover frame and rotary direct handle	The access probe of 1.0mm diameter shall not penetrate.	IP40
Circuit breaker with cover frame and rotary extended handle	Totally protected against ingress of dust and water jets from any direction	IP65

Type suffix according to the mounting position

S-Type

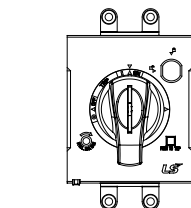
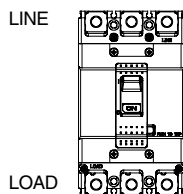

L-Type

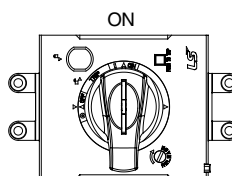
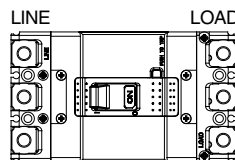

R-Type

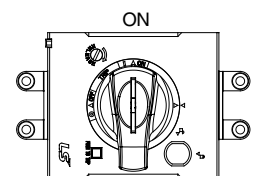
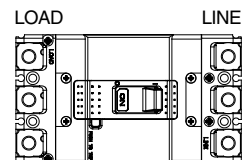

Terminal covers



Short type

The terminal covers are applied to the circuit-breaker to prevent accidental contact with live parts and thereby guarantee protection against direct contacts.

Two types by length are available and provide IP40 degree of protection.

- **Short type covers, TCS:**

For fixed circuit-breakers with rear terminals and for moving parts of plug-in.

- **Long type covers, TCL:**

For fixed circuit-breakers with front, front extended, front for cables terminals.



Long type

Type		Pole	Breaker	
Long Type	Short Type		MCCB	ELCB
TCS12	TCL12	2P		
TCS13	TCL13	3P	ABN50c/60c/100c	EBN50c/60c/100c
TCS14L	TCL14L	4P Line	ABS30c/50c/60c	EBS30c/50c/60c
TCS14R	TCL14R	4P Load		
TCS22	TCL22	2P		
TCS23	TCL23	3P	ABS125c	EBS125c
TCS24L	TCL24L	4P Line	ABH50c/125c	EBH50c/125c
TCS24R	TCL24R	4P Load		
TCS33	TCL33	2/3P		
TCS34L	TCL34L	4P Line	ABN250c, ABS250c	EBN250c, EBS250c
TCS34R	TCL34R	4P Load	ABH250c	EBH250c
T1-43A	-	2, 3P	ABN/S/H/L400c	EBN/S/H/L400c
T1-44A	-	4P		
T1-63A	-	2, 3P	ABN/S/L800c	EBN/S/L800c
T1-64A	-	4P		



Short type construction



Long type construction

Insulation barriers



Insulation barrier allows the insulation characteristics between the phases at the connections to be increased. They are mounted from the front, even with the circuit-breaker already installed, inserting them into the corresponding slots.

They are incompatible with both the insulating terminal covers.

It is possible to mount the phase separating partitions between two circuit-breakers side by side.

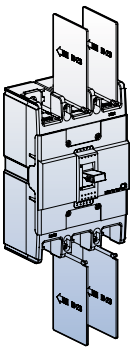

Type	Breaker	
	MCCB	ELCB
IB-13	ABN50c/60c/100c	EBN50c/60c/100c
	ABS30c/50c/60c	EBS30c/50c/60c
IB-23	ABS125c	EBS125c
	ABH50c/125c	EBH50c/125c
IB-33	ABN250c, ABS250c	EBN250c, EBS250c
	ABH250c	EBH250c
IBL400	ABN/S/H/L400c	EBN/S/H/L400c
IBL800	ABN/S/L800c	EBN/S/L800c



Insulation barriers for line side are provided as standard.

Rear connection terminals

Rear connection terminals are used to adapt the circuit breakers to switchboards or other applications that require rear connection.

There are two kinds of rear connection terminals.

- Flat type
- Round type

Round type terminals



Breaker	For 2-	For 3-	For 4-
ABN100c 50AF	RTR1-52	RTR1-53	-
ABN100c 100AF	RTR1-102	RTR1-103	RTR1-104
ABH125c	RTR2-102	RTR2-103	RTR2-104
ABH250c	RTR3-202	RTR3-203	RTR3-204

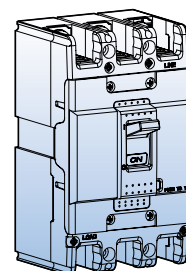
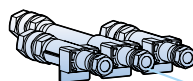
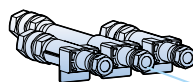
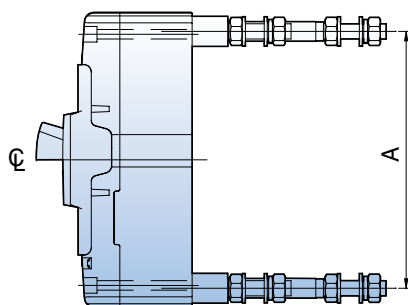

Flat type terminals



Breaker	For 2-pole	For 3-pole	For 4-pole
ABN100c	RTB1-102	RTB1-103	RTB1-104
ABH125c	RTB2-102	RTB2-103	RTB2-104
ABH250c	RTB3-202	RTB3-203	RTB3-204
AB□400c	X-402	X-403	X-404
AB□800c	X-802	X-803	X-804

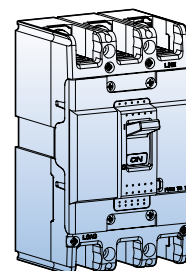
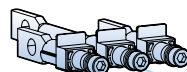
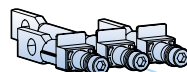
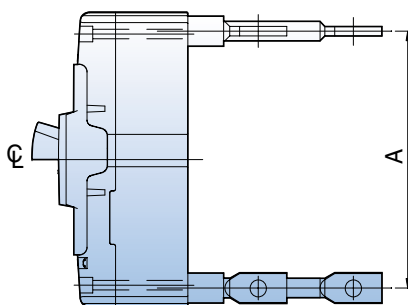

Plug-in devices



Plug-in base

Plug-in device makes it possible to extract and/or rapidly replace the circuit breaker without having to touch connections for ship and important installations.

The plug-in base is the fixed part of the plug-in version of the circuit-breaker.

It will be installed directly on the back plate of panel.

The circuit-breaker is racked out by unscrewing the top and bottom fixing screws.

Normal type Plug-in MCCB

- MCCB current rating up to 250A
- generally used in switchgears

Double-row type Plug-in MCCB

- For 125AF MCCB
- generally used in branch circuits

Type names of blocks

Breaker	Arrangement	P lug-in block	Remark
ABN100c	Normal	PB-A3-FR	
	Single-row	PB-A3-1DB	
	Double-row	PB-A3-2DB	
	Line-only	PB-A3-FRL	
ABH125c	Normal	PB-C3-FR	
	Single-row	PB-C3-1DB	
	Double-row	PB-C3-2DB	
	Line-only	PB-C3-FRL	
ABH250c	Normal	PB-D3-FR	
400AF	Line-only	PB-I3-FRL	
800AF	Line-only	PB-J3-FRL	



Plug-in type MCCB (plug-in terminal built)



ABH103c plug-in type



ABH203c plug-in type

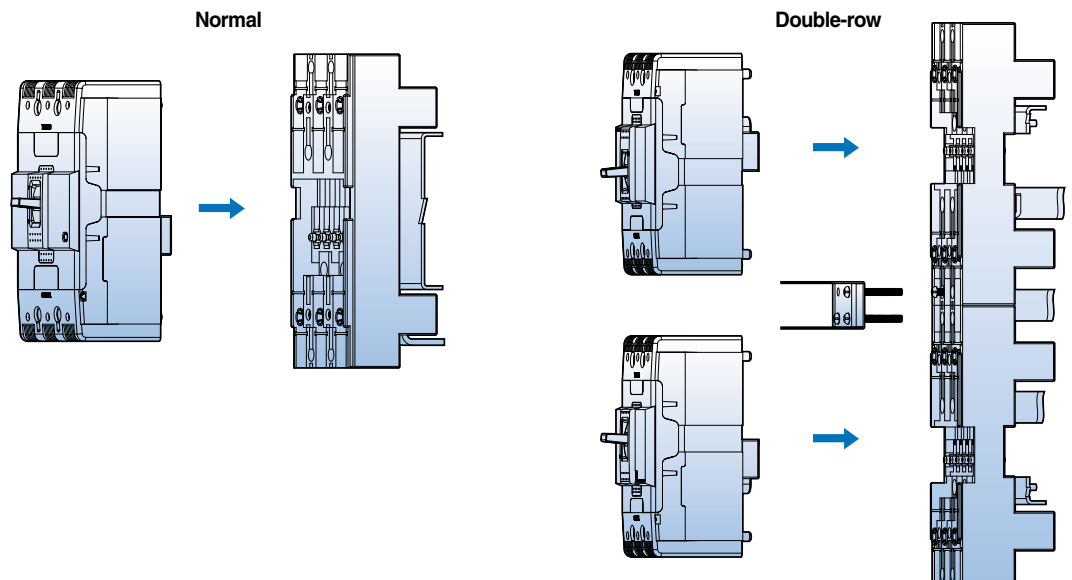

Type numbering system

MCCB

AB	S	10	3	C	M / 100A	AX	SHT=220V																											
MCCB	Type	Ampere Frame	Pole	Series	Application	Rated current	Accessory	Control voltage of accessory																										
	N N-Type	3 30AF	2 2-pole	- Conventional	- General purpose	<table border="1"> <thead> <tr> <th colspan="2">Rated current</th> </tr> </thead> <tbody> <tr><td>3A</td><td>150A</td></tr> <tr><td>5A</td><td>175A</td></tr> <tr><td>10A</td><td>200A</td></tr> <tr><td>15A</td><td>225A</td></tr> <tr><td>20A</td><td>250A</td></tr> <tr><td>30A</td><td>300A</td></tr> <tr><td>40A</td><td>350A</td></tr> <tr><td>50A</td><td>400A</td></tr> <tr><td>60A</td><td>500A</td></tr> <tr><td>75A</td><td>630A</td></tr> <tr><td>100A</td><td>700A</td></tr> <tr><td>125A</td><td>800A</td></tr> </tbody> </table>	Rated current		3A	150A	5A	175A	10A	200A	15A	225A	20A	250A	30A	300A	40A	350A	50A	400A	60A	500A	75A	630A	100A	700A	125A	800A	AX Auxiliary Switch	
Rated current																																		
3A	150A																																	
5A	175A																																	
10A	200A																																	
15A	225A																																	
20A	250A																																	
30A	300A																																	
40A	350A																																	
50A	400A																																	
60A	500A																																	
75A	630A																																	
100A	700A																																	
125A	800A																																	
	S S-Type	5 50AF	3 3-pole	a Hi-MEC	M Motor protection		AL Alarm Switch	SHT																										
	H H-Type	6 60AF	4 4-pole	b Meta-MEC			SHT Shunt Trip	AC/DC 12V																										
	L L-Type	10 100/125AF		c Metasol			UVT Undervoltage trip	AC/DC 24V																										
		20 225/250AF					DH Rotary handle (Direct)	AC/DC 48V																										
		40 400AF					EH Rotary handle (Extended)	AC/DC 60V																										
		80 800AF					RTR Rear terminal	AC/DC 100V-130V																										
							RTB Rear terminal	AC/DC 200V-250V																										
								AC 380V-450V																										
								AC 440V-500V																										
								UVT																										
								AC/DC 24V																										
								AC/DC 48V																										
								AC/DC																										
								100V-110V																										
								AC/DC																										
								200V-220V																										
								AC 380V-440V																										
								AC 440V-480V																										

ELCB

EB	S	10	3	C / 100A	30mA	AX																										
ELCB	Type	Ampere Frame	Pole	Series	Rated residual current	Accessory																										
	N N-Type	3 30AF	2 2-pole	- Conventional	<table border="1"> <thead> <tr> <th colspan="2">Rated current</th> </tr> </thead> <tbody> <tr><td>3A</td><td>150A</td></tr> <tr><td>5A</td><td>175A</td></tr> <tr><td>10A</td><td>200A</td></tr> <tr><td>15A</td><td>225A</td></tr> <tr><td>20A</td><td>250A</td></tr> <tr><td>30A</td><td>300A</td></tr> <tr><td>40A</td><td>350A</td></tr> <tr><td>50A</td><td>400A</td></tr> <tr><td>60A</td><td>500A</td></tr> <tr><td>75A</td><td>630A</td></tr> <tr><td>100A</td><td>700A</td></tr> <tr><td>125A</td><td>800A</td></tr> </tbody> </table>	Rated current		3A	150A	5A	175A	10A	200A	15A	225A	20A	250A	30A	300A	40A	350A	50A	400A	60A	500A	75A	630A	100A	700A	125A	800A	AX Auxiliary Switch
Rated current																																
3A	150A																															
5A	175A																															
10A	200A																															
15A	225A																															
20A	250A																															
30A	300A																															
40A	350A																															
50A	400A																															
60A	500A																															
75A	630A																															
100A	700A																															
125A	800A																															
	S S-Type	5 50AF	3 3-pole	a Hi-MEC	30mA	AL Alarm Switch																										
	H H-Type	6 60AF	4 4-pole	b Meta-MEC	100/200/500mA	DH Rotary handle (Direct)																										
	L L-Type	10 100/125AF		c Metasol		EH Rotary handle (Extended)																										
		20 225/250AF				RTR Rear terminal																										
		40 400AF				RTB Rear terminal																										
		80 800AF																														

Characteristics curves

Breaker types

MCCB
ABN50c/60c/100c
ABS30c/50c/60c
ELCB
EBN50c/60c/100c
EBS30c/50c/60c

Rated current: 3~30A

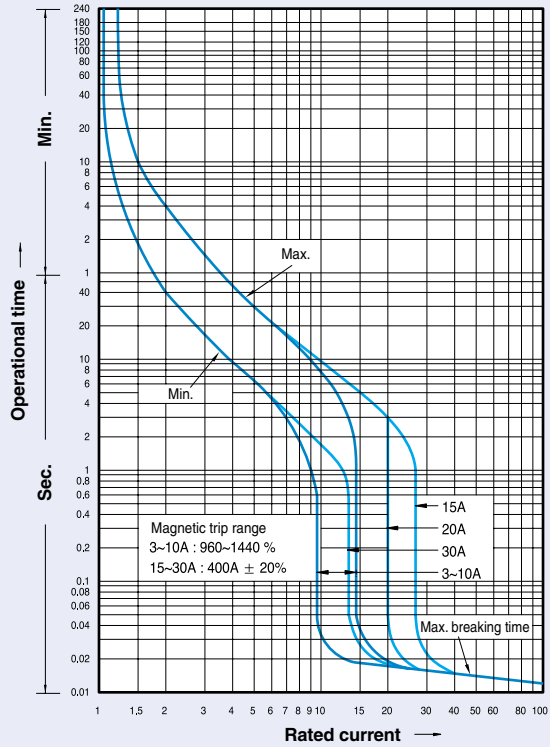

Compensation curves

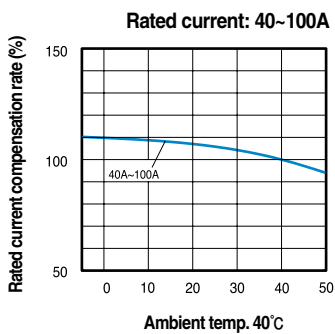
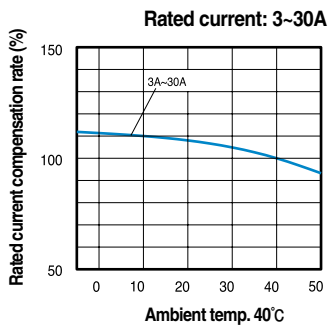

Rated current: 40~100A

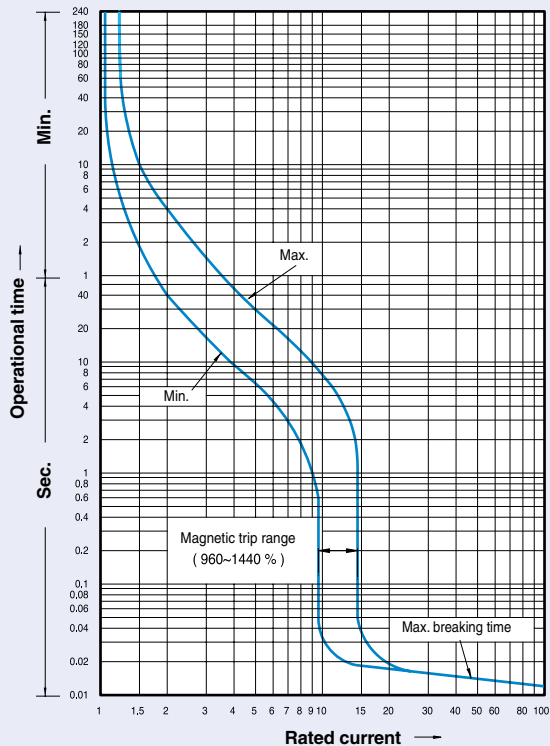

Breaker types

MCCB
ABS125c
ABH50c/125c
ELCB
EBS125c
EBH50c/125c

Rated current: 15~30A, 40~100A

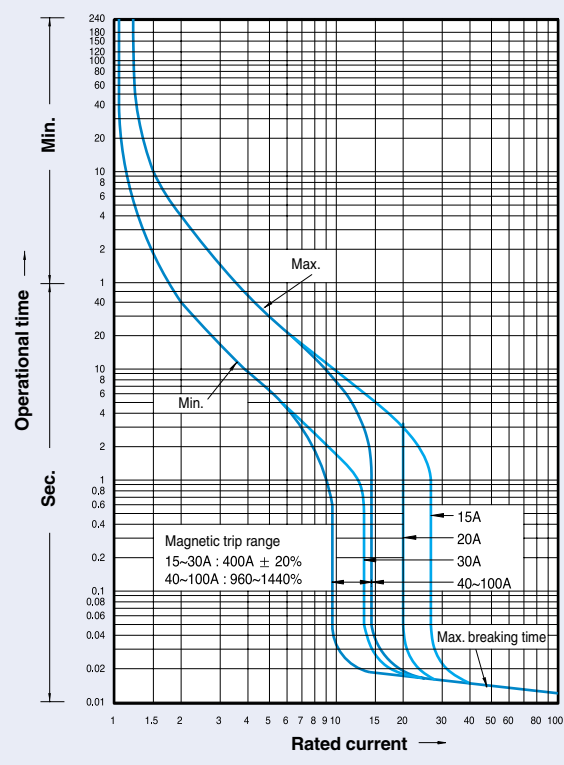

Compensation curves

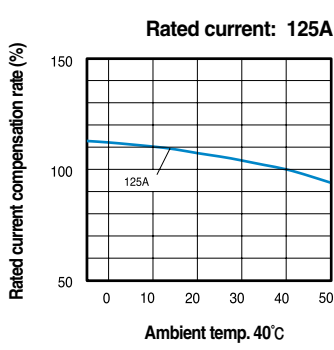
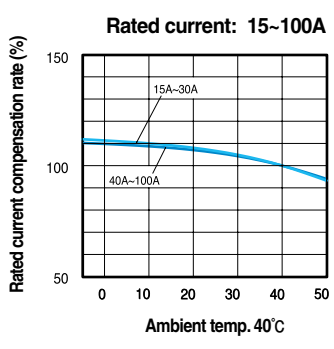

Rated current: 125A

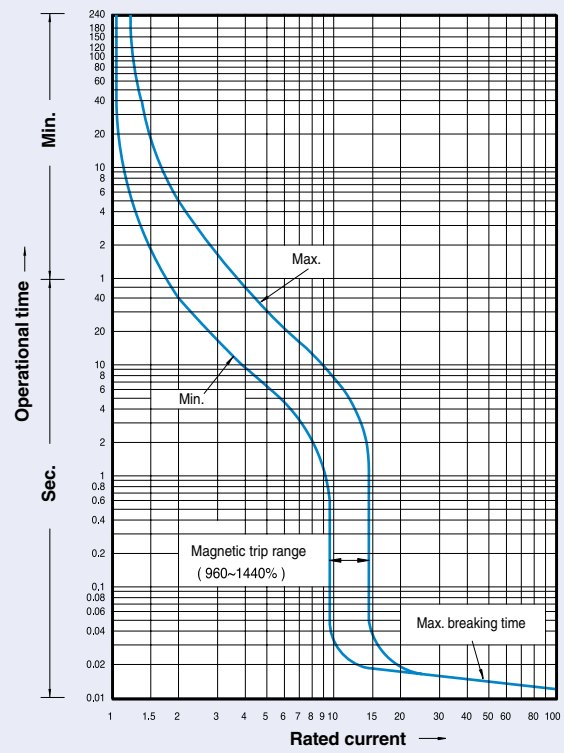

Characteristics curves

Breaker types

MCCB
ABN250c, ABS250c
ABH250c
ELCB
EBN250c, EBS250c
EBH250c

Rated current: 100~225A

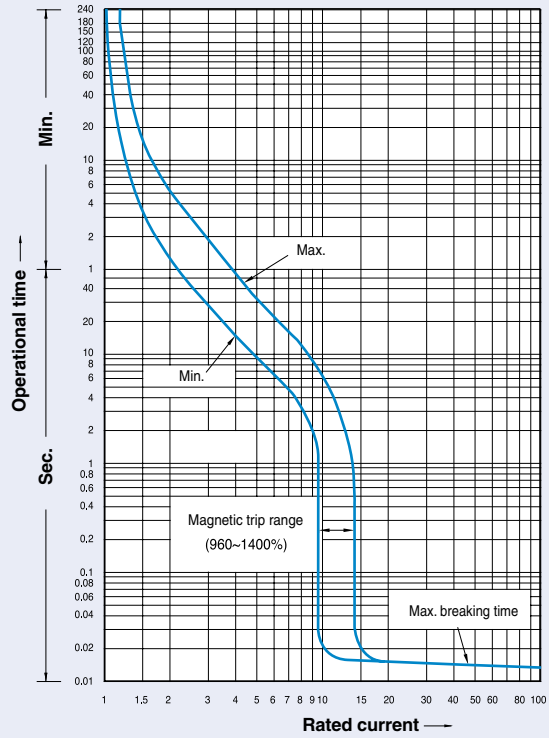

Compensation curves

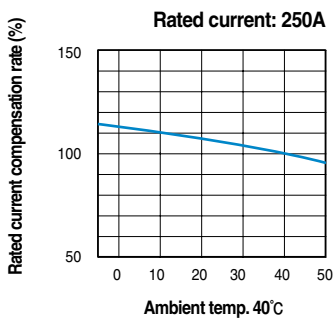
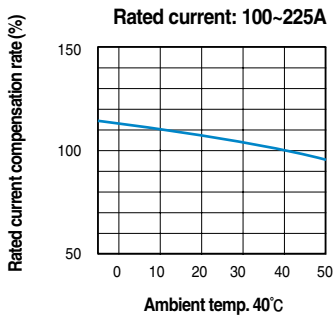

Rated current: 250A

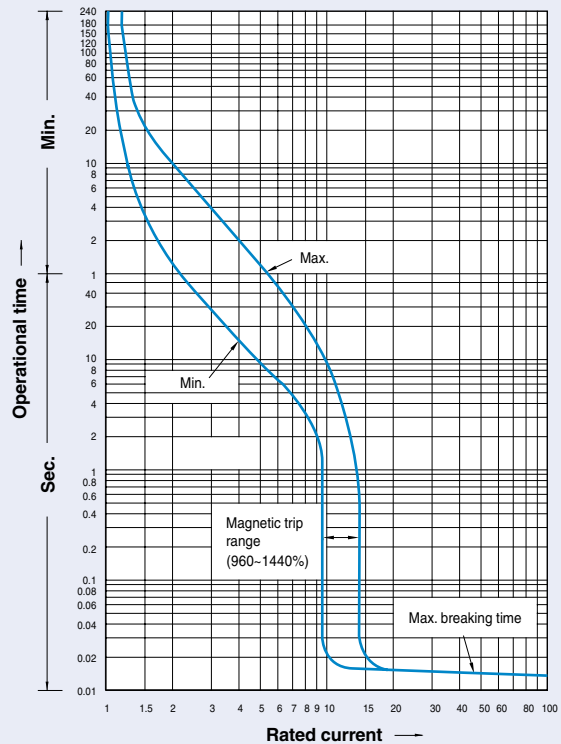

Breaker types

MCCB
ABN400c, ABS400c, ABH400c, ABL400c
ABN800c, ABS800c, ABL800c
ELCB
EBN400c, EBS400c, EBH400c, EBL400c
EBN800c, EBS800c, EBL800c

Rated current: 250~400A

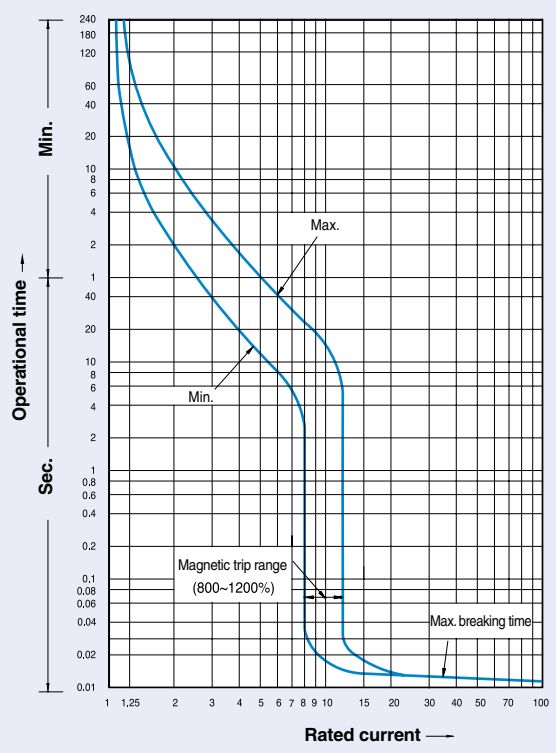

Compensation curves

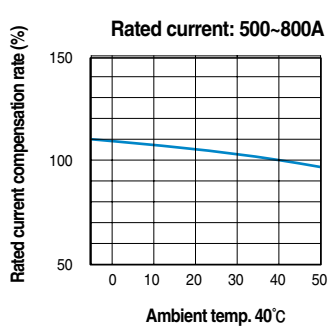
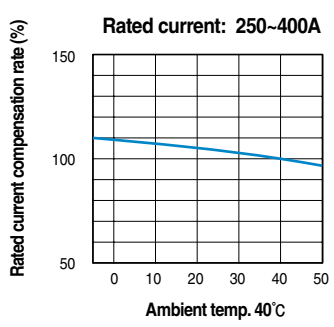

Rated current: 500~800A

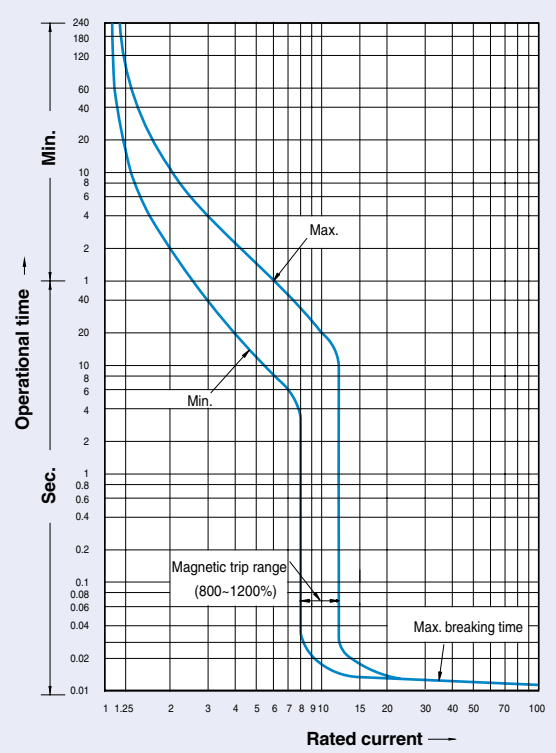

Dimensions

MCCB

ABN50c	ABS30c
ABN60c	ABS50c
ABN100c	ABS60c

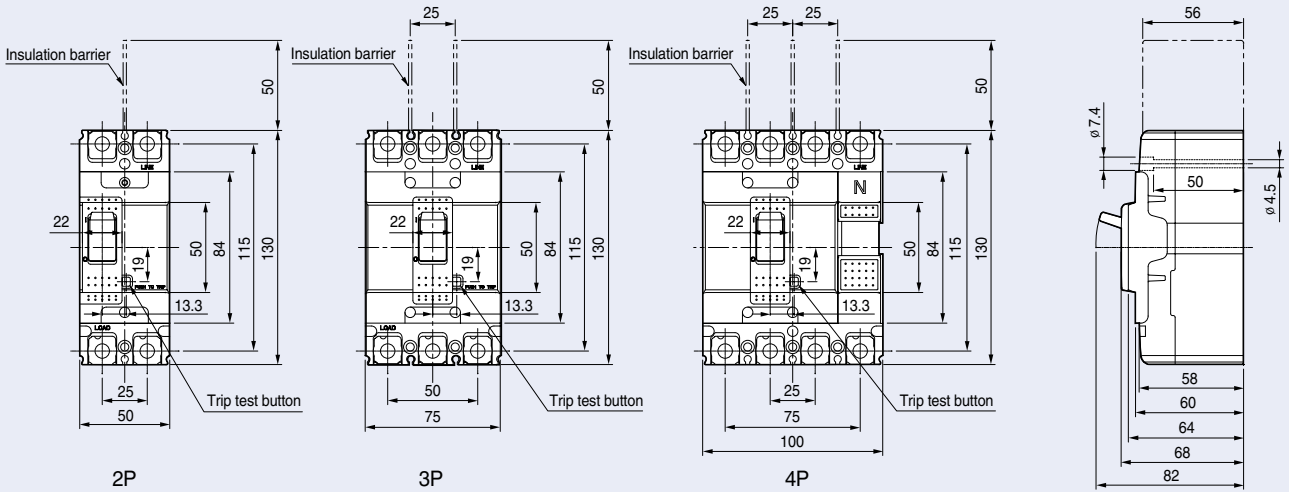

Terminal details

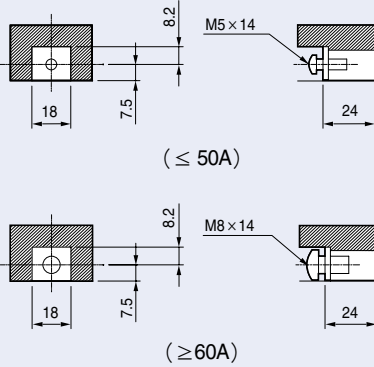

Connecting

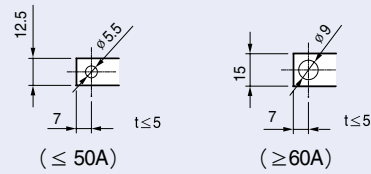

Panel drilling

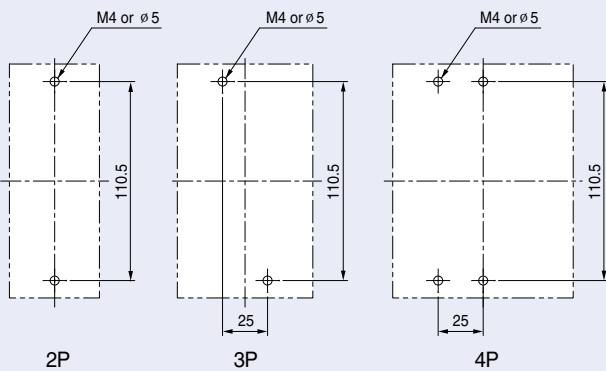

Front panel cutting

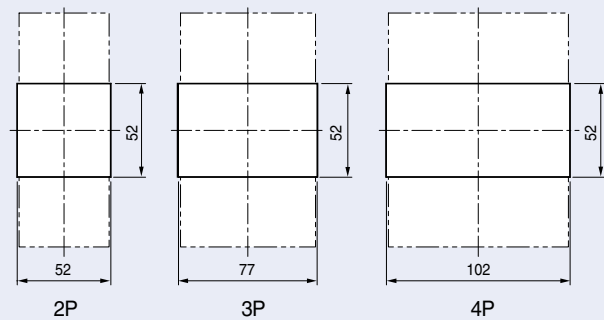

MCCB

ABS125c

ABH50c

ABH125c

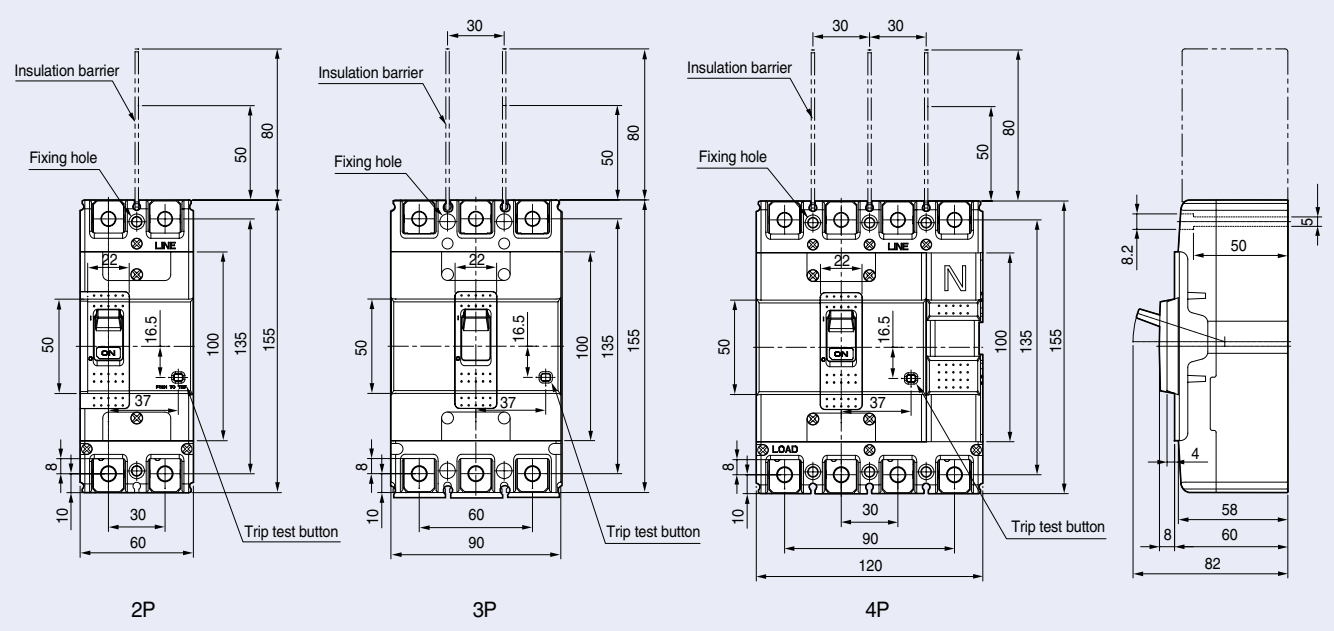

Terminal details

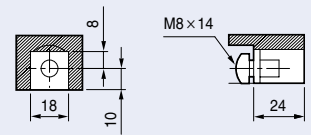

Connecting

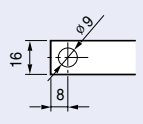

Panel drilling

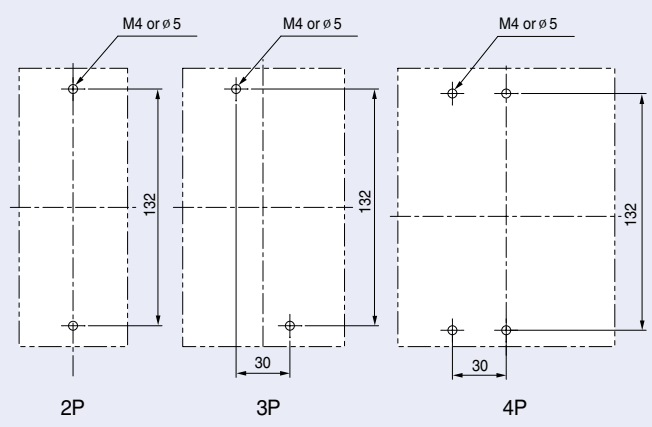

Front panel cutting

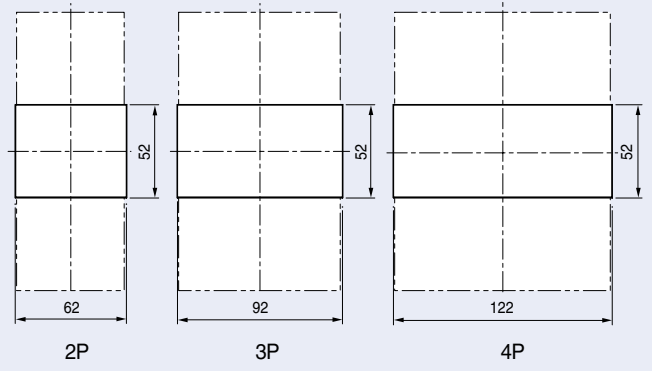

Dimensions

MCCB

ABN250c

ABS250c

ABH250c

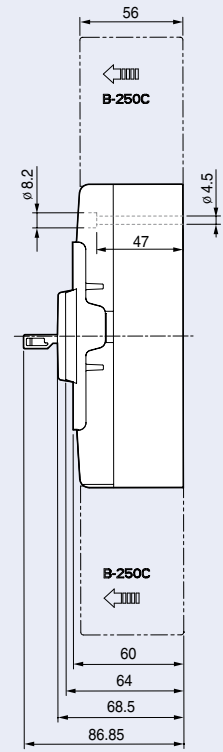
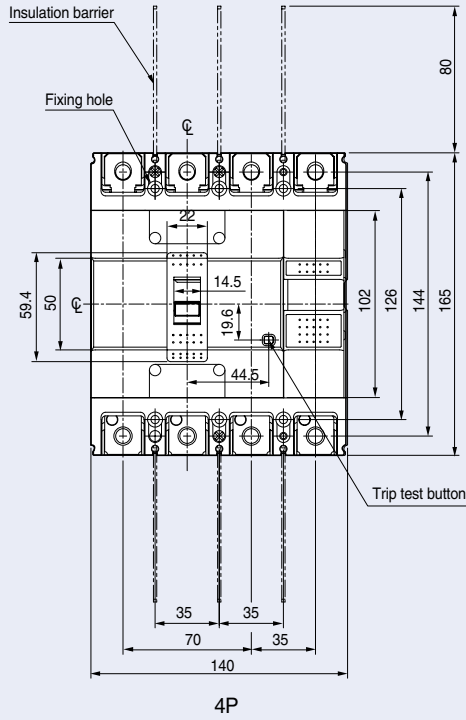
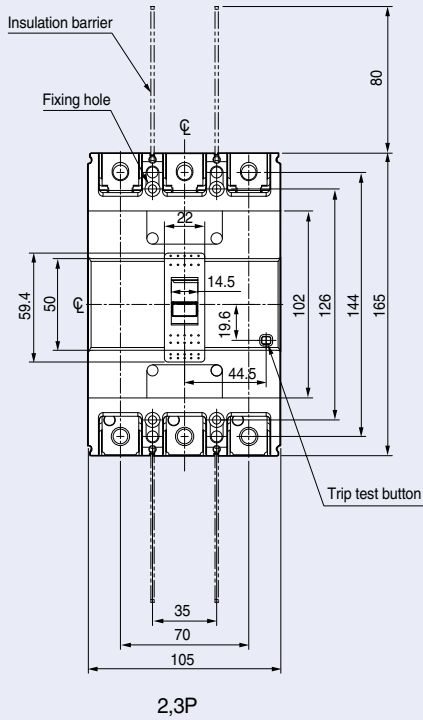

Terminal details

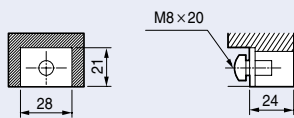

Connecting

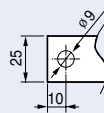

Panel drilling

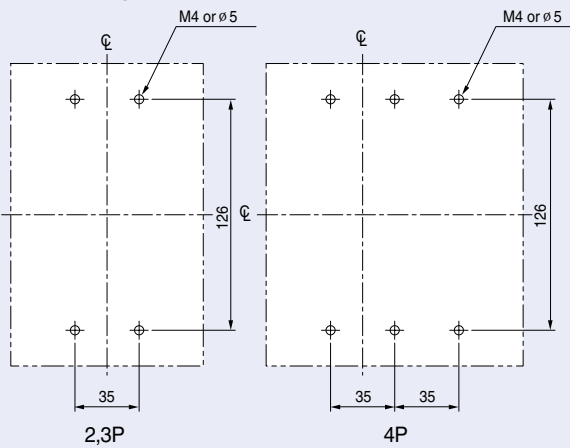

Front panel cutting

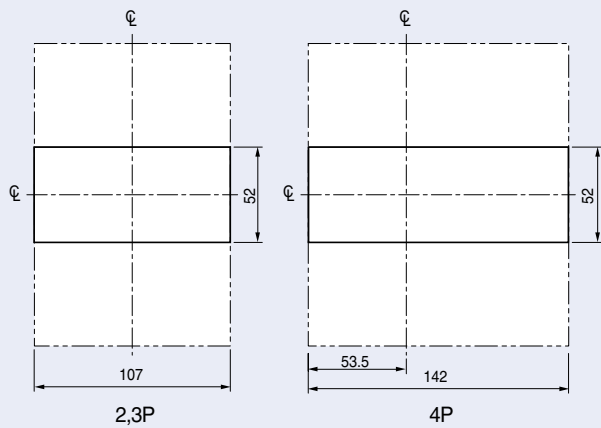

MCCB

- ABN400c
- ABS400c
- ABH400c
- ABL400c

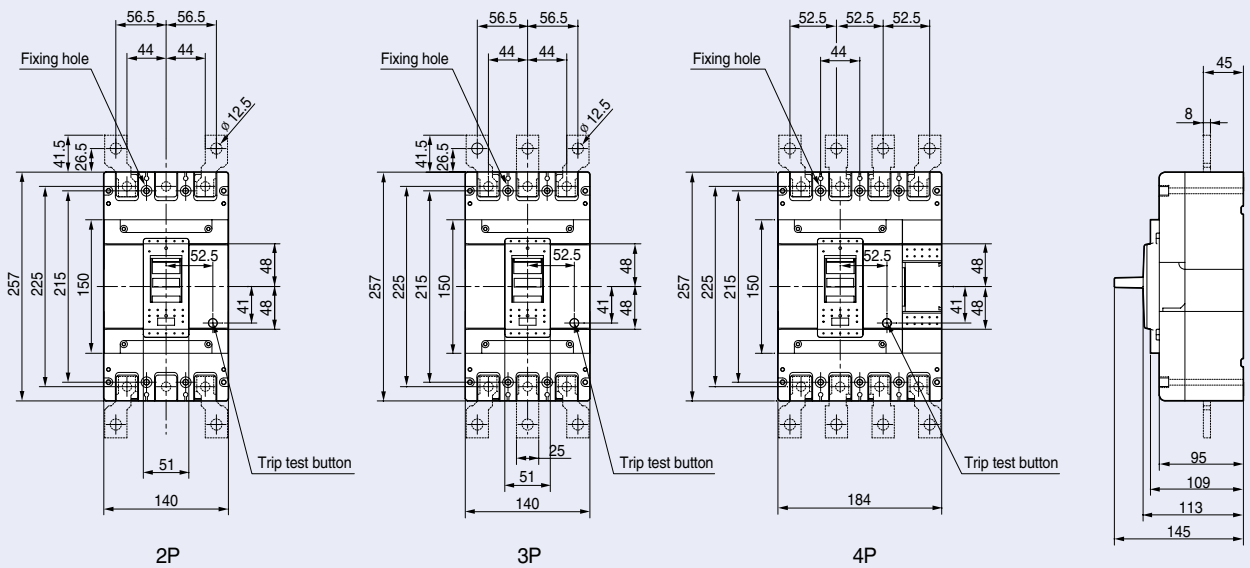

Terminal details

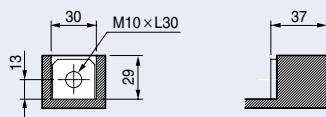

Connecting

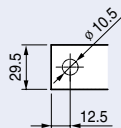

Panel drilling

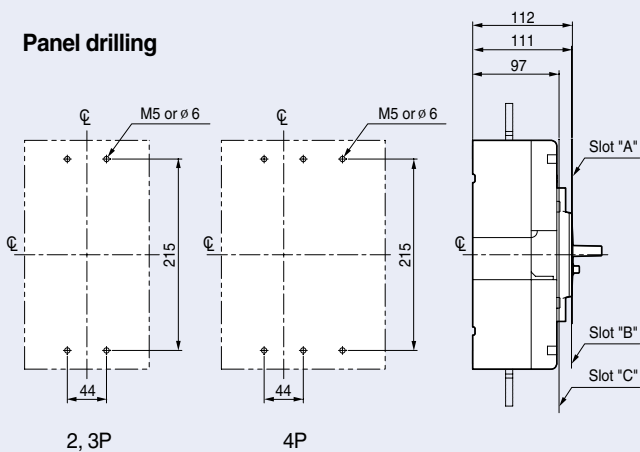

Front panel cutting

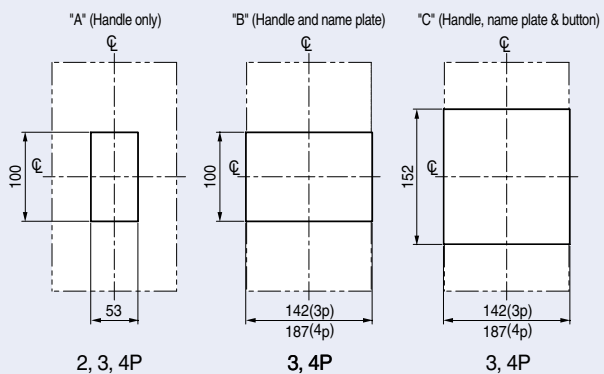

Dimensions

MCCB

ABN800c

ABS800c

ABL800c

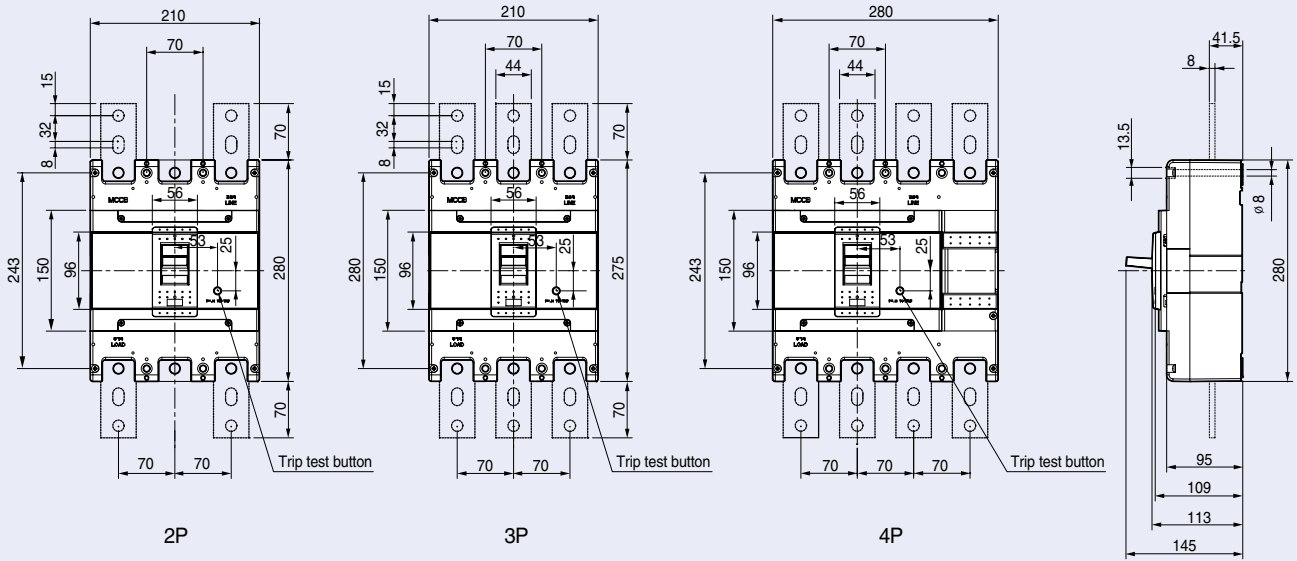

Terminal details

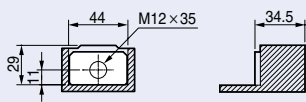

Connecting

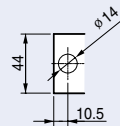

Panel drilling

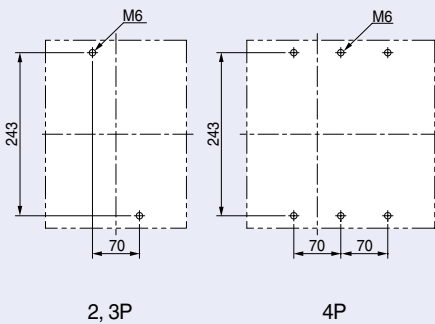

Front panel cutting

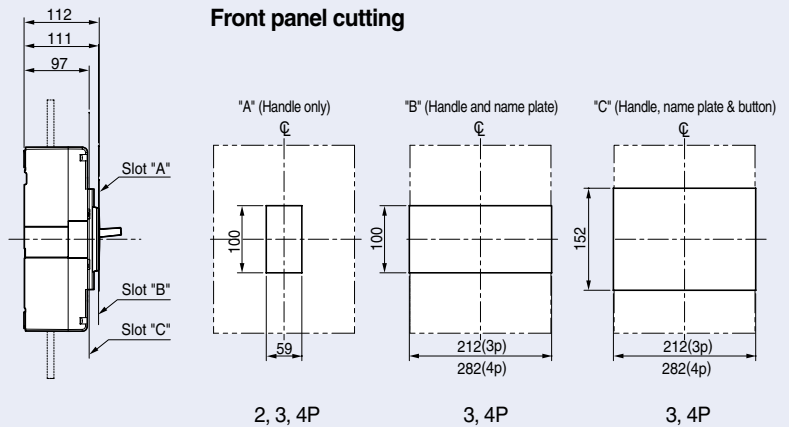

ELCB

EBS30c	EBS50c
EBS60c	EBS100c

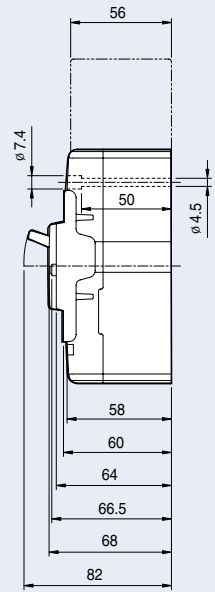
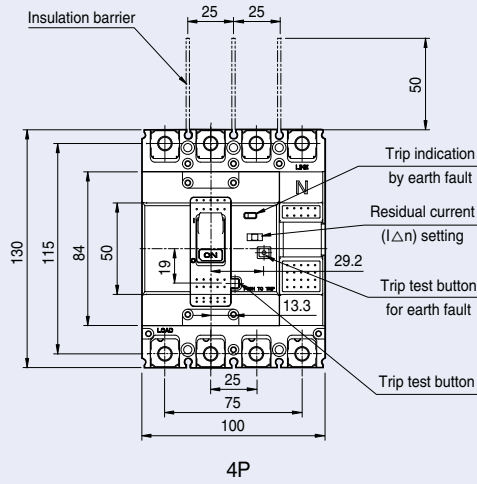
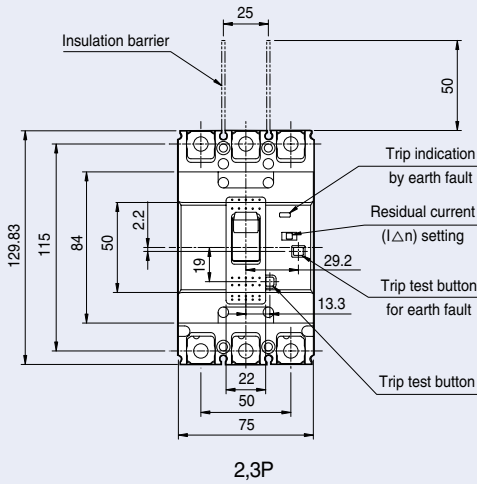

Terminal details

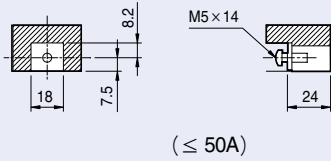

(≤ 50A)

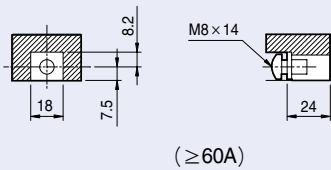

(≥ 60A)

Connecting

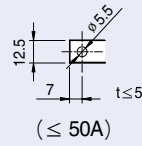

(≤ 50A)

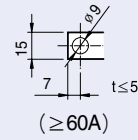

(≥ 60A)

Panel drilling

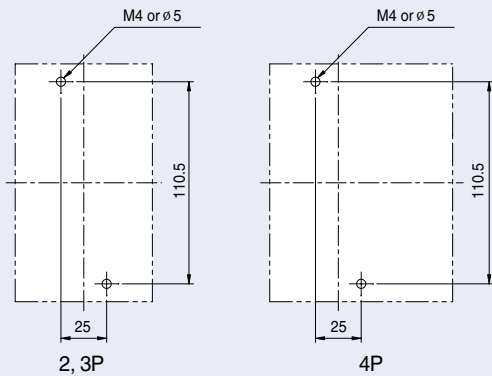

Front panel cutting

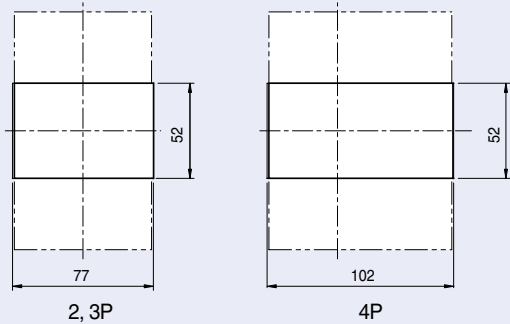

Dimensions

ELCB

EBS125c

EBH50c

EBH125c

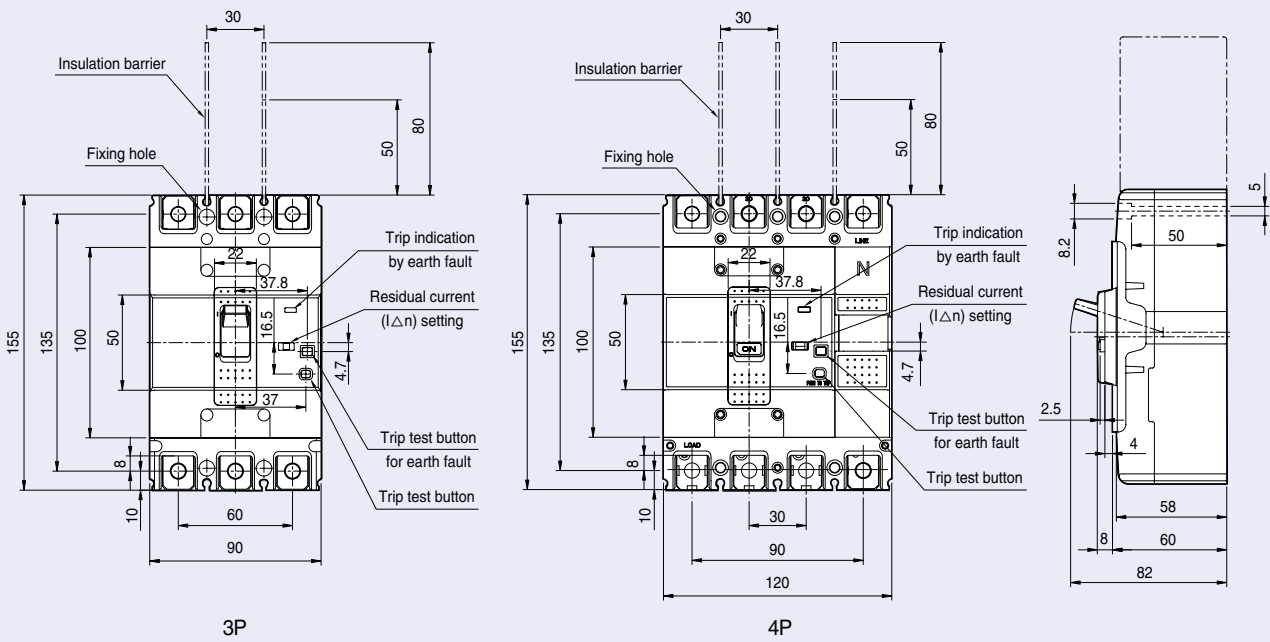

Terminal details

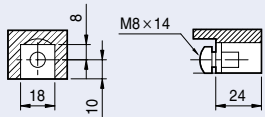

Connecting

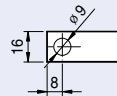

Panel drilling

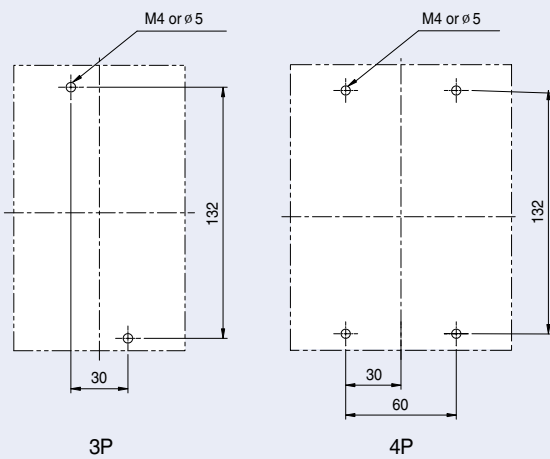

Front panel cutting

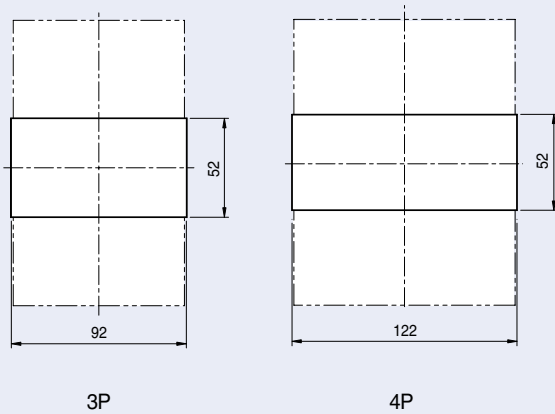

ELCB

EBN250c

EBS250c

EBH250c

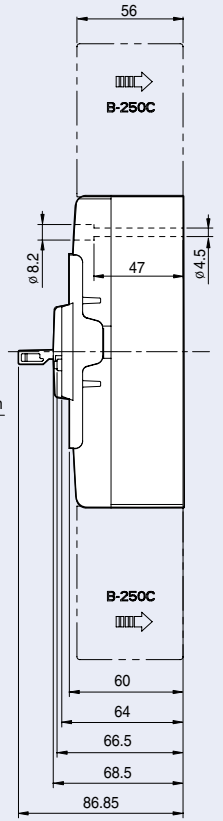
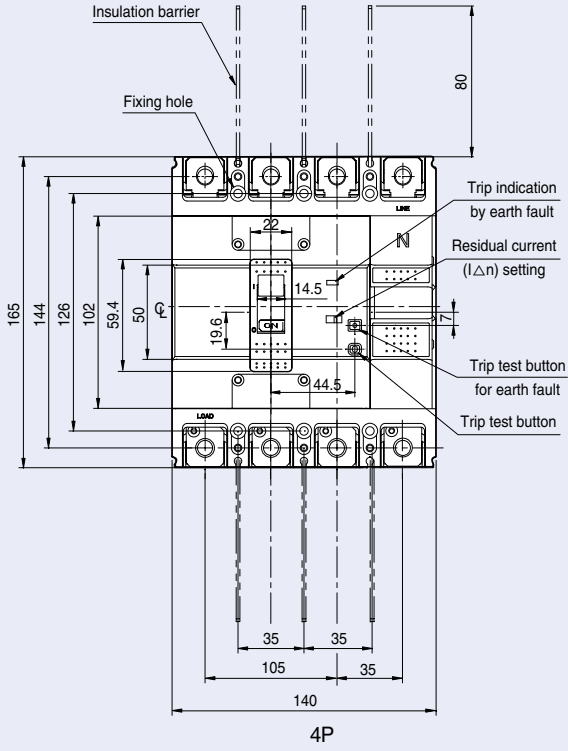
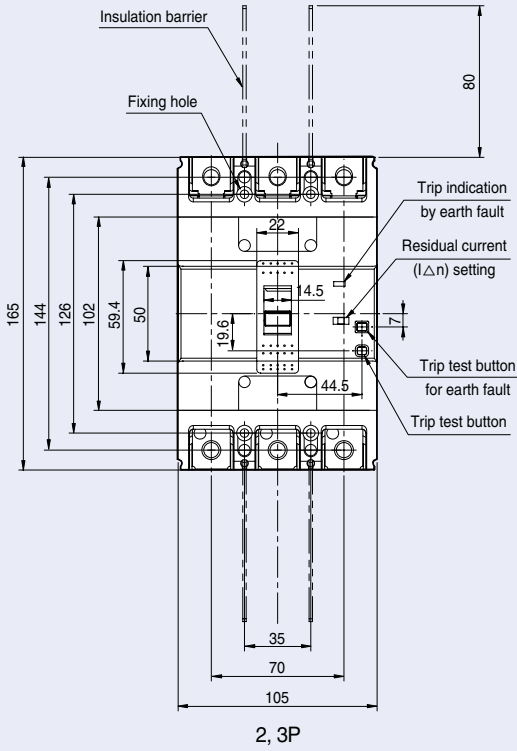

Terminal details

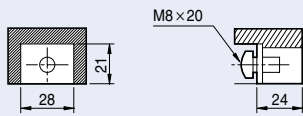

Connecting

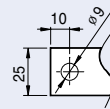

Panel drilling

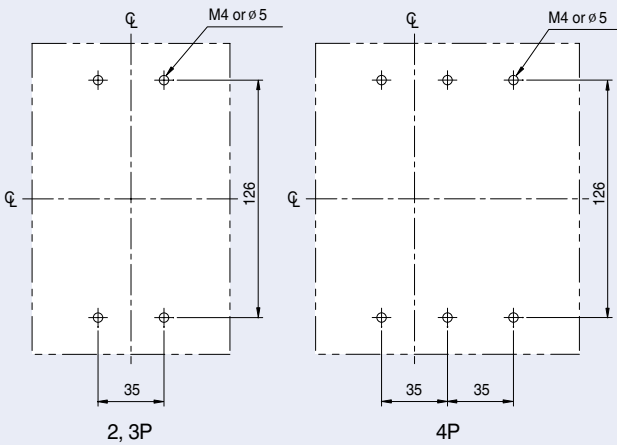

Front panel cutting

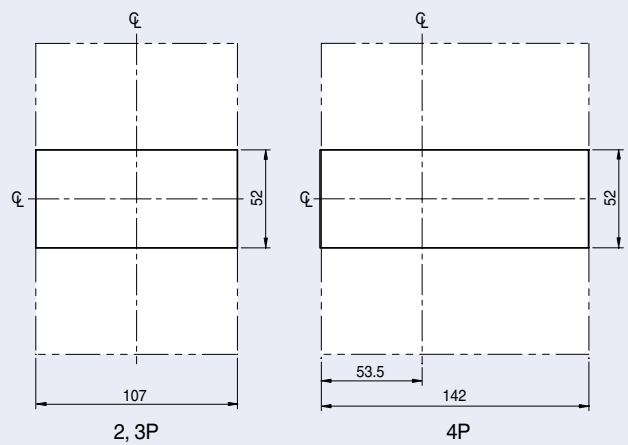

Dimensions

ELCB

- EBN400c
- EBS400c
- EBH400c
- EBL400c

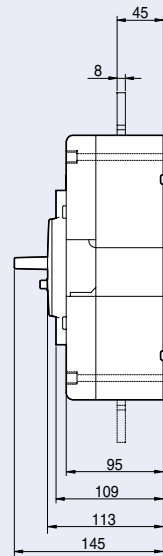
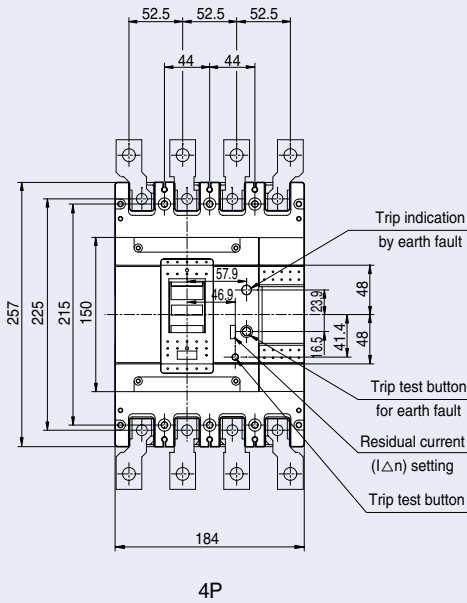
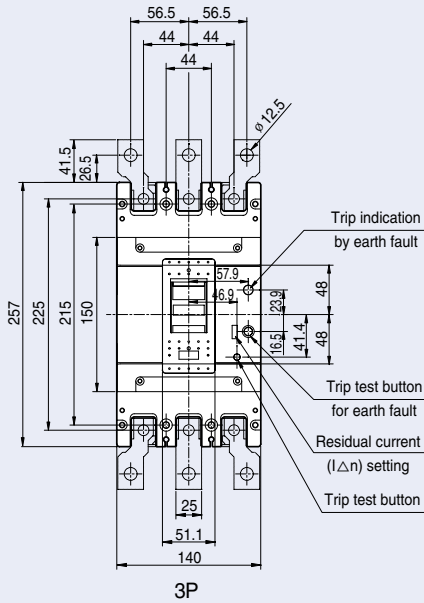

Terminal details

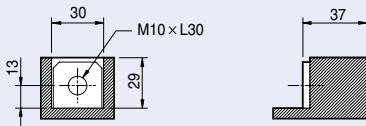

Connecting

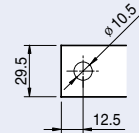

Panel drilling

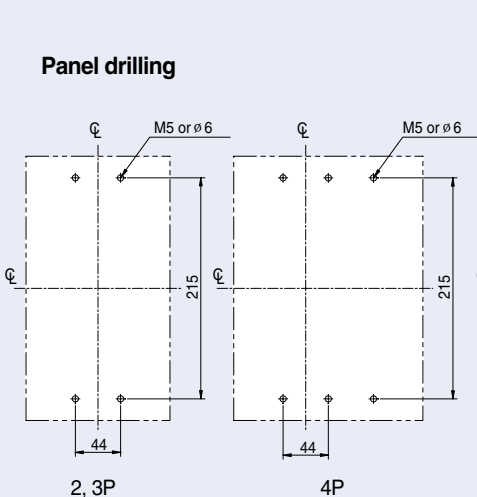

Front panel cutting

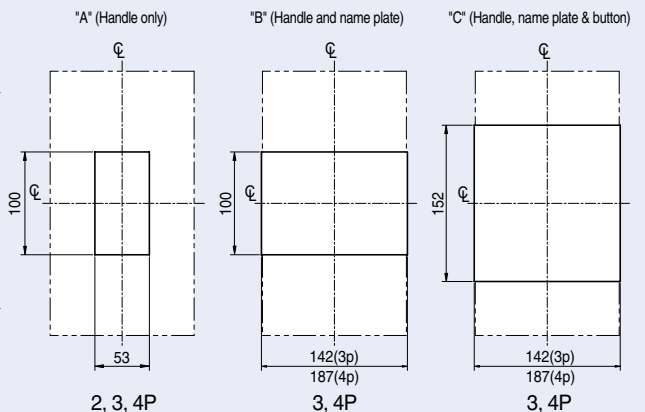

ELCB

- EBN800c
- EBS800c
- EBL800c

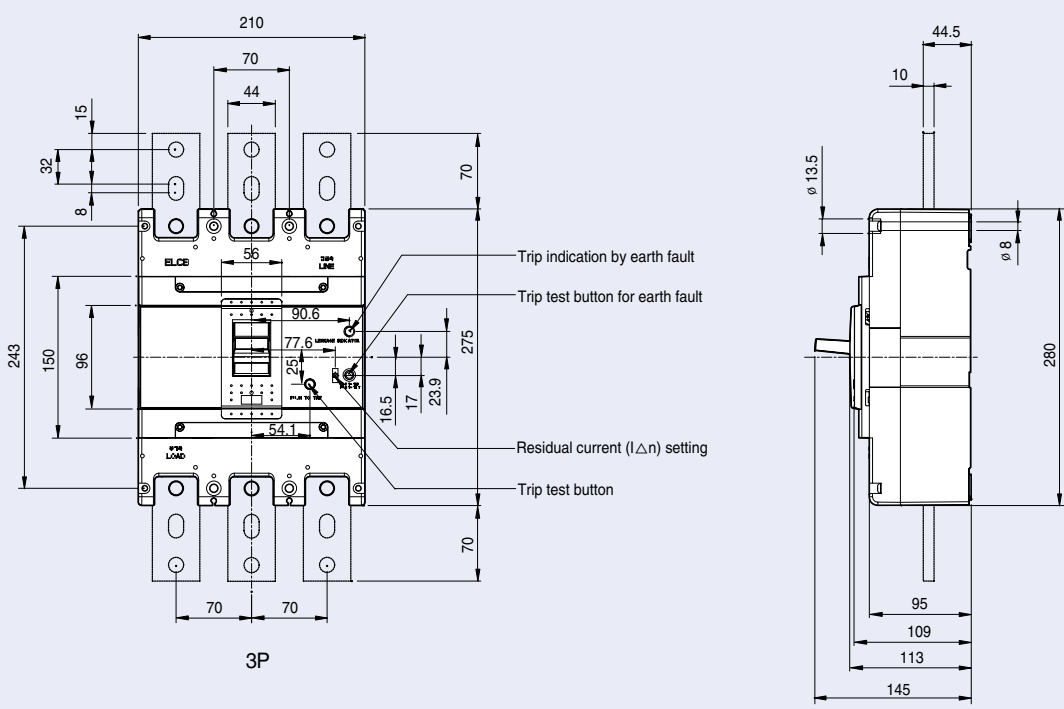

Terminal details

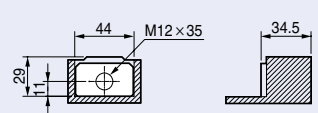

Connecting

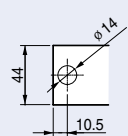

Panel drilling

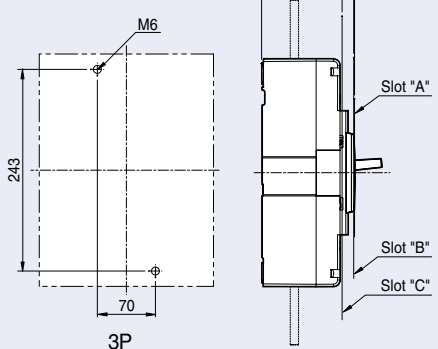

Front panel cutting

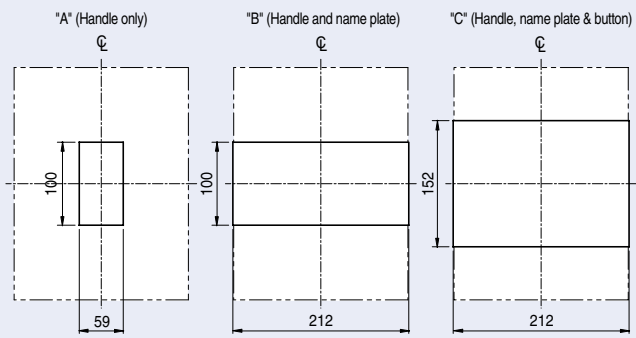

Rear connection terminals

Bar type

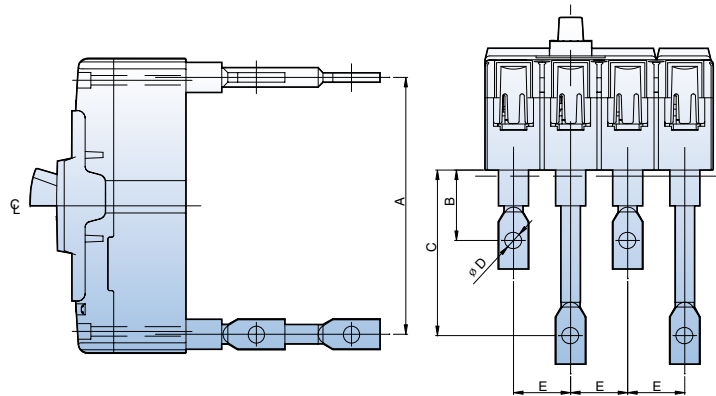

MCCB	A	B	C	D	E
ABN100c	115	37	87	∅ 8.5	25
ABH125c	135	37	87	∅ 8.5	30
ABH250c	144	57.5	93.5	∅ 8.5	35
ABS400c	225	72	-	∅ 14	44
ABS800c	243	108.7	-	∅ 14	70

Round type

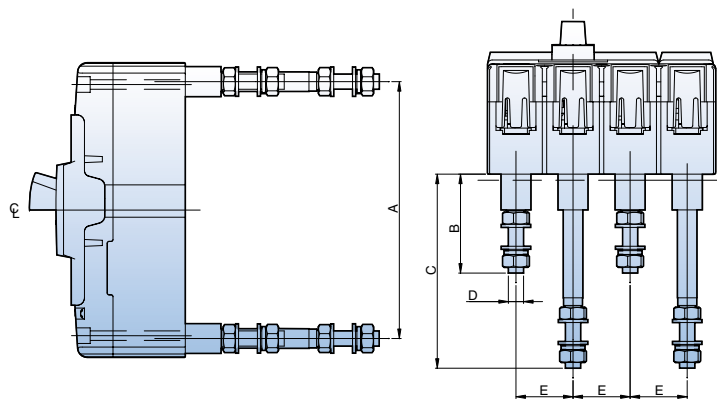

MCCB	A	B	C	D	E
ABN100c 50AF	115	42	92	M6	25
ABN100c 100AF	115	52	102	M8	25
ABH125c	135	52	102	M8	30
ABH250c	144	70	106	M8	35

Rotary handles

Direct mounting type (D-Handle)

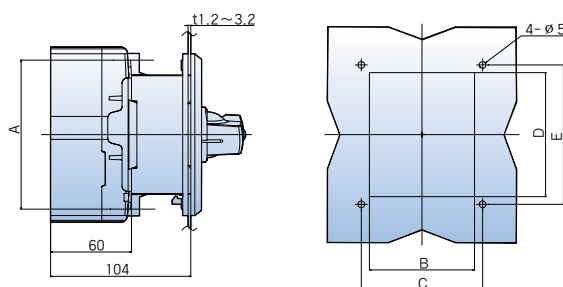

Type	A (mm)	B (mm)	C (mm)	D (mm)	E (mm)	Remarks
DH100	110.5	78	90	92	103.4	-
DH125	132	94	105	108	120	-
DH250	126	108	121	110	122	-



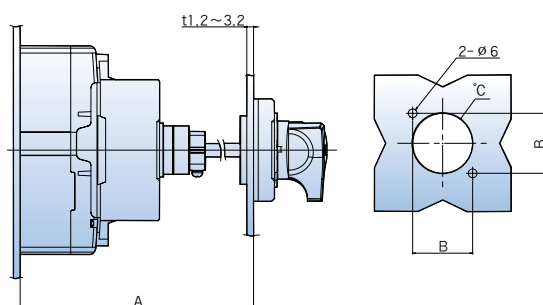











Extended mounting type (E-Handle)

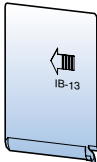
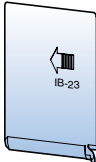

Type	A (mm)	B (mm)	C (mm)	Remarks
EH100	min 150, max 573.5 (SHAFT469mm)	47	∅ 53	-
EH125	min 150, max 573.5 (SHAFT469mm)	47	∅ 53	-
EH250	min 150, max 571.5 (SHAFT469mm)	47	∅ 53	-

Standard accessories

The following accessories for mounting, connection and insulation are standard items and are packed with Metasol series circuit breakers.

Item	ABN100c	ABH125c	ABH250c	400AF	800AF
Fixing screw					
	2P: 2EA (M4 × 60) 3P: 2EA (M4 × 60) 4P: 4EA (M4 × 60)	2P: 2EA (M4 × 60) 3P: 2EA (M4 × 60) 4P: 4EA (M4 × 60)	2P: 2EA (M4 × 55) 3P: 4EA (M4 × 55) 4P: 4EA (M4 × 55)	2P: 2EA (M6 × 100) 3P: 4EA (M6 × 100) 4P: 4EA (M6 × 100)	2P: 2EA (M6 × 100) 3P: 4EA (M6 × 100) 4P: 4EA (M6 × 100)
Terminal bolt					
	15~30A 2P: 4EA (M5 × 14) 3P: 6EA (M5 × 14) 4P: 8EA (M5 × 14) 40~100A 2P: 4EA (M8 × 14) 3P: 6EA (M8 × 14) 4P: 8EA (M8 × 14)	2P: 4EA (M8 × 14) 3P: 6EA (M8 × 14) 4P: 8EA (M8 × 14)	2P: 4EA (M8 × 20) 3P: 6EA (M8 × 20) 4P: 8EA (M8 × 20)	2P: 4EA (M10 × 30) 3P: 6EA (M10 × 30) 4P: 8EA (M10 × 30)	2P: 2EA (M12 × 35) 3P: 6EA (M12 × 35) 4P: 8EA (M12 × 35)
Insulation barrier					
	2P: 1EA 3P: 2EA 4P: 3EA	2P: 1EA 3P: 2EA 4P: 3EA	2P: 1EA 3P: 2EA 4P: 3EA	2P: 1EA 3P: 2EA 4P: 3EA	2P: 1EA 3P: 2EA 4P: 3EA

Connection

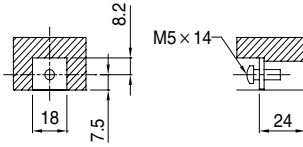
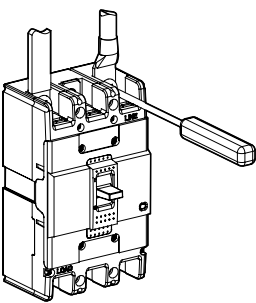
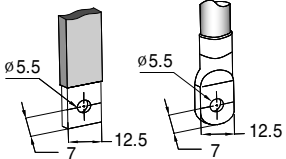
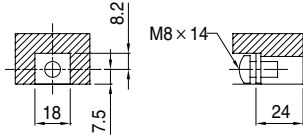
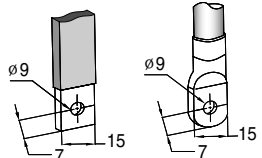
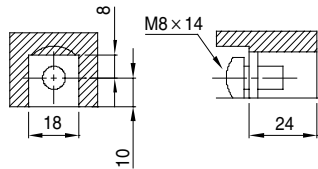
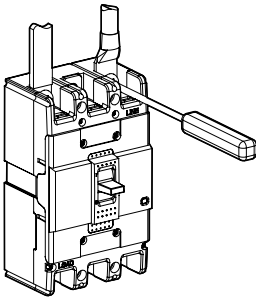
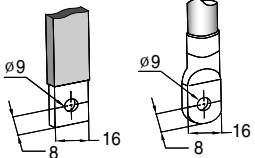
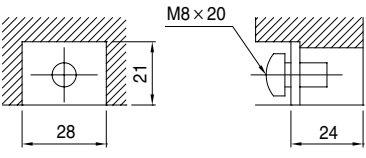
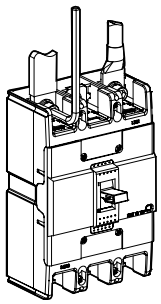
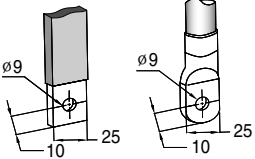
MCCB	Terminal (mm)	Tightening torque (kgf · cm)	Conductor (mm)
ABN100c	<p>[3~30A]</p> 	 <p>M5 : 23 ~ 28 M8 : 55 ~ 75</p>	<p>[15~30A]</p> 
	<p>[40~100A]</p> 		<p>[40~100A]</p> 
ABH125c		 <p>M8 : 55 ~ 75</p>	
ABH250c		 <p>M8 : 80 ~ 130</p>	

Connection

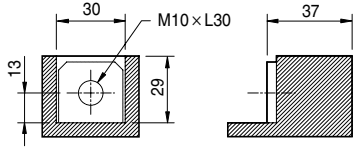
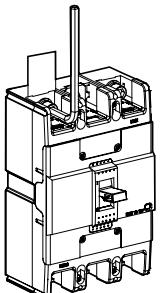
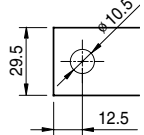
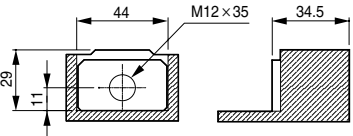
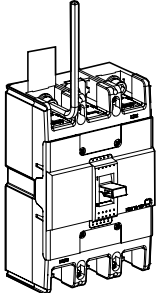
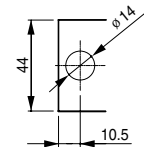
MCCB	Terminal (mm)	Tightening torque (kgf · cm)	Conductor (mm)
400AF		<p>M10 : 240-300</p> 	
800AF		<p>M12 : 400-500</p> 	

Safety clearance

When installing a circuit breaker, safety clearances must be kept between the breaker and panels, bars and other protection devices installed nearby. These safety clearances are depend on the ultimate breaking capacity and are defined by tests carried out in accordance with standard IEC 60947-2.

When a short circuit interruption occur, high temperatures pressures are present in and above the arc chambers of the circuit-breaker. In order to allow the pressure to be distributed and to prevent fire and arcing or short-circuit currents, safety clearances are required.

A: Minimum distance to metallic top panels

Frame size	Description	A(mm)	
		460V	250V
100AF	ABN50c	40	25
	ABN60c	40	25
	ABN100c	50	30
	ABS30c	30	25
	ABS50c	40	30
	ABS60c	40	30
125AF	ABS125c	50	40
	ABH50c	50	40
	ABH125c	100	80
250AF	ABN250c	100	80
	ABS250c	100	80
	ABH250c	100	80
400AF	ABN400c	100	80
	ABS400c	100	80
	ABH400c	100	80
	ABL400c	100	80
800AF	ABN800c	100	80
	ABS800c	100	80
	ABL800c	100	80

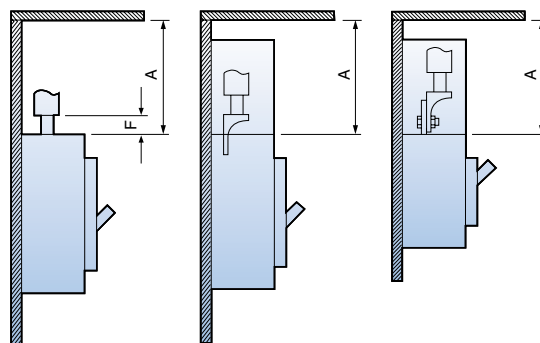

Safety clearance

B: Minimum distance between the lower and the upper breakers

- C1: Minimum distance between the lower breaker and the bare terminal of the upper breaker
- C: C1+ the dimension of bare part of conductor

Frame size	Description	C1 (mm)		C (mm)
		460V	250V	
100AF	ABN50c	40	25	
	ABN60c	40	25	
	ABN100c	50	30	
	ABS30c	30	25	
	ABS50c	40	30	
	ABS60c	40	30	
125AF	ABS125c	50	40	
	ABH50c	50	40	
	ABH125c	100	80	
250AF	ABN250c	100	80	
	ABS250c	100	80	
	ABH250c	100	80	
400AF	ABN400c	100	80	
	ABS400c	100	80	
	ABH400c	100	80	
	ABL400c	100	80	
800AF	ABN800c	100	80	
	ABS800c	100	80	
	ABL800c	100	80	

The dimension of bare conduct + C1

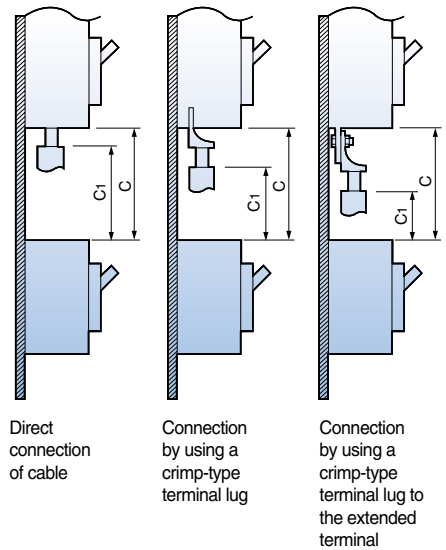

Direct connection of cable

Connection by using a crimp-type terminal lug

Connection by using a crimp-type terminal lug to the extended terminal

Insulated length of main terminal of circuit breaker

- D1: Connection by solderless terminal with taping
- D2: Connection by busbar with taping
- D3: Connection by solderless terminal and using insulation barrier
- D4: Connection by busbar and using insulation barrier

Frame size	Description	D1 (mm)	D2 (mm)	D3 (mm)	D4 (mm)
100AF	ABN50c	The dimension of bare conduct + 20	40	The dimension of bare conduct + 20	40
	ABN60c		40		40
	ABN100c		50		50
	ABS30c		30		30
	ABS50c		40		40
	ABS60c		40		40
125AF	ABS125c		50		50
	ABH50c		50		50
	ABH125c		50		50
250AF	ABN250c		50		50
	ABS250c		50		50
	ABH250c		50		50
400AF	ABN400c	100	100		
	ABS400c	100	100		
	ABH400c	100	100		
	ABL400c	100	100		
800AF	ABN800c	150	150		
	ABS800c	150	150		
	ABL800c	150	150		

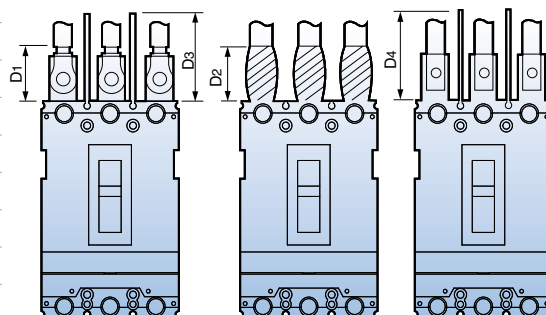

Safety clearance

Minimum distance to metallic side panels

Frame size	Description	E(mm)	
		460V	250V
100AF	ABN50c	25	15
	ABN60c	25	15
	ABN100c	25	15
	ABS30c	20	15
	ABS50c	25	15
	ABS60c	25	15
125AF	ABS125c	25	15
	ABH50c	25	15
	ABH125c	50	20
250AF	ABN250c	50	15
	ABS250c	50	15
	ABH250c	50	15
400AF	ABN400c	80	40
	ABS400c	80	40
	ABH400c	80	40
	ABL400c	80	40
800AF	ABN800c	80	40
	ABS800c	80	40
	ABL800c	80	40

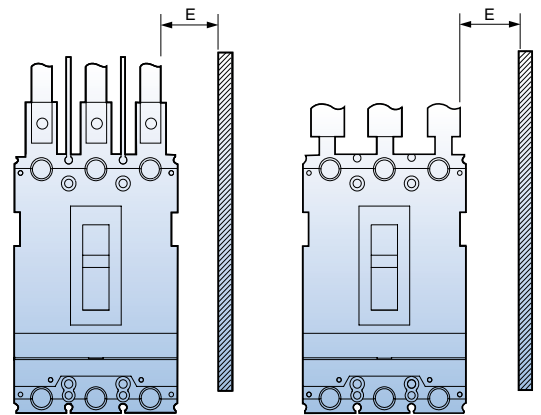

Distance of bare cables or busbars

Frame size	Description	F(mm)
100AF	ABN50c	10
	ABN60c	10
	ABN100c	-
	ABS30c	5
	ABS50c	10
	ABS60c	10
125AF	ABS125c	-
	ABH50c	10
	ABH125c	20
250AF	ABN250c	-
	ABS250c	-
	ABH250c	-
400AF	ABN400c	10
	ABS400c	10
	ABH400c	10
	ABL400c	10
800AF	ABN800c	10
	ABS800c	10
	ABL800c	10

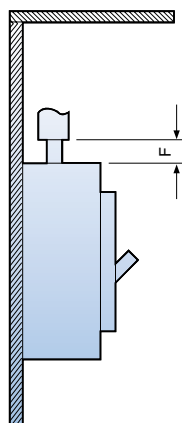

Safety clearance

Minimal distance between two adjacent breakers (With terminal covers)

Frame size	Description	G(mm)
100AF	ABN50c	0
	ABN60c	0
	ABN100c	0
	ABS30c	0
	ABS50c	0
	ABS60c	0
125AF	ABS125c	0
	ABH50c	0
	ABH125c	0
250AF	ABN250c	0
	ABS250c	0
	ABH250c	0
400AF	ABN400c	0
	ABS400c	0
	ABH400c	0
	ABL400c	0
800AF	ABN800c	0
	ABS800c	0
	ABL800c	0

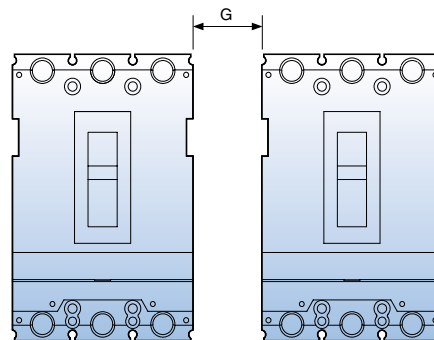

Standards & Approval

Metasol series circuit breakers and auxiliaries comply with the following international standard:

- IEC 60947-1
Low-voltage switchgear and controlgear - Part 1: General rules
- IEC 60947-2
Low-voltage switchgear and controlgear - Part 2: Circuit-breakers

The following certificates are available on a request.

- CE Declaration of conformity
- Certificate of conformance test (CB) - IEC 60947
- Full type test report issued by KEMA

CE conformity marking

The CE conformity marking shall indicate conformity to all the obligations imposed on the manufacturer, as regards his products, by virtue of the European Community directives providing for the affixing of the CE marking.

When the CE marking is affixed on a product, it represents a declaration of the manufacturer or of his authorized representative that the product in question conforms to all the applicable provisions including the conformity assessment procedures.

IEC CB TEST CERTIFICATE		Ref. Certificate No.
		NL-14196/A1
IEC SYSTEM FOR MUTUAL RECOGNITION OF TEST CERTIFICATES FOR ELECTRICAL EQUIPMENT (IECEE) CB SCHEME		
Issued by:	KEMA Quality B.V.	
Product:	Moulded case circuit-breaker	
Applicant:	LS Industrial Systems Co., Ltd.	1026-6, Hogye-dong, Dong-an-gu Anyang-si, Gyeonggi-do Korea, Republic of
Manufacturer:	LS Industrial Systems Co., Ltd.	1026-6, Hogye-dong, Dong-an-gu Anyang-si, Gyeonggi-do Korea, Republic of
Factory:	LS Industrial Systems Co., Ltd. Cheongju Plant	1, Songjeong-dong, Heungdeok-gu Cheongju-si, Chungcheongbuk-do Korea, Republic of
Rating and principal characteristics:	3 poles MCCB (thermal/magnetic) I _n = 15, 20, 30, 40, 50, 60, 75, 100, 125 A U _e = 220, 240, 250, 415, 440, 460 Vac U _i = 750 Vac U _{imp} = 8 kV I _{cu} = 100 kA at 220, 240, 250 V and 50 kA at 415, 440, 460 V, I _{cs} = 100%I _{cu} Rated frequency = 50/60 Hz Cat A.	
Trade mark (if any):	LS	
Model/Type reference:	ABH53c, ABS103c, ABH103c	
Additional information:	WMT procedure	
Sample of product tested to be in conformity with IEC:	60947-2(ed.4)	
Test Report Ref. No.:	2109959.51 (156 pages)	
This CB Test Certificate is issued by the National Certification Body:		
KEMA Quality B.V. Ulrechtseweg 310 P.O. Box 5185 6802 ED Arnhem The Netherlands		
Signed by: H.L. Schendstok		
Date of issue: 2008-05-21		

IEC CB TEST CERTIFICATE		Ref. Certificate No.
		NL-14216/A2
IEC SYSTEM FOR MUTUAL RECOGNITION OF TEST CERTIFICATES FOR ELECTRICAL EQUIPMENT (IECEE) CB SCHEME		
Issued by:	KEMA Quality B.V.	
Product:	Moulded case circuit-breaker (earth leakage circuit-breaker)	
Applicant:	LS Industrial Systems Co., Ltd.	1026-6, Hogye-dong, Dong-an-gu Anyang-si, Gyeonggi-do Korea, Republic of
Manufacturer:	LS Industrial Systems Co., Ltd.	1026-6, Hogye-dong, Dong-an-gu Anyang-si, Gyeonggi-do Korea, Republic of
Factory:	LS Industrial Systems Co., Ltd. Cheongju Plant	1, Songjeong-dong, Heungdeok-gu Cheongju-si, Chungcheongbuk-do Korea, Republic of
Rating and principal characteristics:	3 pole Earth leakage circuit-breaker (thermal/magnetic with electronic ground fault detection: 30 mA, 100/200/500 mA) I _n = 15, 20, 30, 40, 50, 60, 75, 100 and 125A U _e = 220, 240, 250 and 415, 440, 460 Vac U _i = 460 Vac U _{imp} = 8 kV I _{cu} = 100 kA at 220, 240, 250 V and I _{cs} = 90 kA at 415, 440, 460 V I _{cs} = 100%I _{cu} Rated frequency = 50/60 Hz Cat A.	
Trade mark (if any):	LS	
Model/Type reference:	EBS 103c, EBH 53c, EBH103c	
Additional information:	WMT procedure	
Sample of product tested to be in conformity with IEC:	60947-2(ed.4)	
Test Report Ref. No.:	2109959.54	
This CB Test Certificate is issued by the National Certification Body:		
KEMA Quality B.V. Ulrechtseweg 310 P.O. Box 5185 6802 ED Arnhem The Netherlands		
Signed by: H.L. Schendstok		
Date of issue: 2008-06-05		

Standard Use Environment

Standard Use Environment for Molded Case Circuit Breaker

The operation characteristic of Molded Case Circuit Breaker including short-circuit, overload, endurance and insulation is often influenced largely by external environment and thus should be applied appropriately with conditions of the place where it is used taken into consideration. In particular, the operation characteristic of the circuit breaker with a thermal magnetic trip element (FTU, FMU, ATU) applied changes a bit with the ambient temperature so you have to adjust the value of power rating accordingly when it is actually in use.

- 1) Ambient Temperature: Within the range of -5°C ~ $+40^{\circ}\text{C}$ (However, the average for the duration of 24 hours must not exceed 35°C .)
- 2) Relative Humidity: Within the range of 45~85%
- 3) Altitude: 2,000m or less (However, if it exceeds 1,000m, atmosphere correction through humidity test and withstand voltage test can be considered.)
- 4) Atmosphere where excessive steam, oil steam, smoke, dust, salt and other corrosive materials do not exist

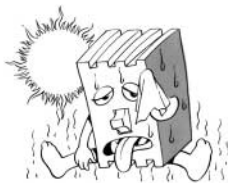

- If a standard circuit breaker is used in high temperature exceeding 40°C , you are advised to use it according to the current corrected for each level of ambient temperature in catalog.
- If used in conditions of highly humidity, the dielectric strength or electric performance may be degraded.



- There is no problem in conduction switch, trip or short circuit isolation in the temperature of -20°C .
- Passing or storage in stone-cold area is allowed in the temperature of 40°C .
- The operating characteristic of the breaker with a thermal magnetic trip element changes as the base ambient temperature is adjusted to 40°C .

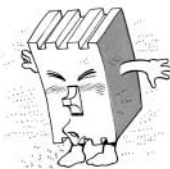

- It is highly recommended to use a dust cover or anti-humid agent if it is used in dusty and humid conditions.
- Excessive vibration may cause a trip break such as connection fault or flaw on mechanical parts.



- If it is left ON or OFF for a long time, it is recommended to switch load current on a regular basis.
- It is recommend to put it in the sealed protection if corrosive gas is prevalent.

Special Use Environment

Environment where Ambient Temperature Exceeds 40°C

The temperature of each module of a Molded Case Circuit Breaker is the sum of temperature increase by conduction and ambient temperature and if the ambient temperature exceeds 40°C the passing current needs to be reduced so that the temperature of such element as internal insulator of MCCB exceed the maximum allowable temperature.

The base ambient temperature of Metasol breaker is set as 40°C so if it has to be used in conditions with higher temperature than this, the rated current is required to be reduced a little as described in the table below.

Table of Rated Current for Metasol MCCB Corrected according to Ambient Temperature

Ampere Frame	Rated current	Model Name of Breaker	Rated current	Table of Rated Current Corrected according to Ambient Temperature (A)							
				10°C	20°C	30°C	40°C	45°C	50°C	55°C	
30	3	ABS30c	3	3	3	3	3	3	3	3	
	5		5	5	5	5	5	5	4		
	10		10	10	10	10	10	10	9	9	
	15		15	15	15	15	15	15	14	13	
	20		20	20	20	20	20	19	19	18	
	30	30	30	30	30	30	29	28	27		
	50	40	ABN50c, ABS50c	40	40	40	40	40	39	38	36
		50		50	50	50	50	50	49	47	45
	60	60	ABN60c, ABS60c	60	60	60	60	60	58	56	55
	100	75	ABN100c	75	75	75	75	75	73	71	68
100		100		100	100	100	100	97	94	91	
125	125	ABH50c, ABS125c, ABH125c	125	125	125	125	125	121	116	107	
250	150	ABN200c, ABS200c, ABH250c	150	150	150	150	150	145	140	128	
	175		175	175	175	175	169	163	150		
	200		200	200	200	200	193	186	171		
	225		225	225	225	225	217	209	193		
	250		250	250	250	250	250	241	233	214	
400	250	ABN400c, ABS400c ABH400c, ABL400c	250	250	250	250	250	246	242	238	
	300		300	300	300	300	295	291	287		
	350		350	350	350	350	345	339	332		
	400		400	400	400	400	394	388	381		
800	500	ABN800c, ABS800c ABL800c	500	500	500	500	500	492	485	477	
	630		630	630	630	630	621	611	602		
	700		700	700	700	700	689	679	668		
	800		800	800	800	800	788	776	764		

Special Use Environment

Table of Rated Current for Metasol ELCB Corrected according to Ambient Temperature

Ampere Frame	Rated current	Model Name of Breaker	Rated current	Table of Rated Current Corrected according to Ambient Temperature (A)							
				10°C	20°C	30°C	40°C	45°C	50°C	55°C	
30	15	EBS30c	15	15	15	15	15	15	15	15	
	20		20	20	20	20	19	19	18		
	30		30	30	30	30	29	28	27		
	50	40	EBN50c, EBS50c	40	40	40	40	40	39	38	36
		50		50	50	50	50	49	47	45	
	60	60	EBN60c, EBS60c	60	60	60	60	60	58	56	55
	100	75	EBN100c	75	75	75	75	75	73	71	68
		100		100	100	100	100	97	94	91	
	125	125	EBH50c, EBS125c, EBH125c	125	125	125	125	125	121	116	107
	250	150	EBN200c, EBS200c, EBH250c	150	150	150	150	150	145	140	128
175		175		175	175	175	169	163	150		
200		200		200	200	200	193	186	171		
225		225		225	225	225	217	209	193		
250		250		250	250	250	241	233	214		
400	250	EBN400c, EBS400c EBH400c, EBL400c	250	250	250	250	250	246	242	238	
	300		300	300	300	300	295	291	287		
	350		350	350	350	350	345	339	332		
	400		400	400	400	400	394	388	381		
800	500	EBN800c, EBS800c EBL800c	500	500	500	500	500	492	485	477	
	630		630	630	630	630	621	611	602		
	700		700	700	700	700	689	679	668		
	800		800	800	800	800	788	776	764		

Special Use Environment

Environment where Ambient Temperature is -5°C or less

Molded Case Circuit Breaker is subject to the effect of low temperature brittle of metal part inside and insulator, or changes in viscosity of lubricating oil in device, extra care should be taken not to have the temperature drop extremely with the use of such device as space heater. In addition, in case of using a thermal magnetic trip element (FTU, FMU, ATU), the operating characteristic changes toward the difficult direction, so you should identify the relationship of protection and correct accordingly.

Although MCCB is not affected by conduction switch, trip, or short circuit isolation in the temperature of -20°C, it is highly recommended to use a temperature maintaining device such as space heater. In addition, transportation and passing in stone-cold area in the temperature as low as -40°C is allowed but it is recommend to leave the status of MCCB off or tripped in order to minimize the effect of brittle due to a low temperature.

High Humidity Condition (Relative Humidity 85% or more)

Using Molded Case Circuit Breaker in a place of high humidity requires a rigorous maintenance including installation of anti-humidity agent within the structure in order to prevent the insulation sag of insulator or corrosion of mechanical parts as a result of high humidity. Also, in case of installing MCCB within the enclosed equipment, a space heater needs to be installed as well to prevent dew condensation that might occur due to a drastic temperature change.

Environment where Petrochemical Gas Exists

The contact material of Molded Case Circuit Breaker is silver or silver alloy which develops creation of petrochemical coat that might cause a poor connection if it gets in contact with petrochemical gas.

However, it is easy for petrochemical coat to be mechanically taken off so it is no problem if make-and break operation occurs frequently but it needs to be switched back and forth between make and break if the operation rarely occurs.

The lead wire of moving contact of Molded Case Circuit Breaker can be disconnected as it is corroded or hardened by petrochemical gas. The silver coating is effective to prevent this from occurring and there is a need to increase durability of MCCB with the use of silver coated lead wire if it is used in environment with thick petrochemical gas.

Environment where Potentially Explosive Gas Exists

It is advised, in principle, not to install a Molded Case Circuit Breaker that switches and inhibits current in a dangerous place such as this one.

Impact of Altitude

If an MCCB is used in an elevated area higher than 2000m sea level, its operating performance is subject to dramatic drop in atmospheric pressure and temperature. For example, the air pressure is reduced to 80% of ordinary pressure at 2,200m and further 50% at 5,500m although the short-circuit performance is not affected. If it is used in areas of high sea level, you can do correction based on the correction parameter table in high altitude environment, as described below.

[Correction Parameter Table for Altitude]

Altitude	Voltage Correction Parameter	Current Correction Parameter
2,000m	1.00	1.00
3,000m	0.91	0.98
4,000m	0.82	0.96
5,000m	0.73	0.94
6,000m	0.65	0.92

* Refer to the correction parameter table in high altitude environment (ANSI C37. 29-1970)

1) How to Correct Voltage:

- If the rated voltage is AC 600V at 4,000m above sea level,
 $600V \text{ (rated voltage)} \times 0.82 \text{ (correction parameter)} = 492V$.

2) How to Correct Current:

- If the rated current is AC 800A at above 4,000m sea level,
 $800A \text{ (rated current)} \times 0.96 \text{ (correction parameter)} = 768A$.

Environment with Vibration and Impulse Exercised

Impact of Vibration and Impulse

An excessive vibration and impulse may cause damage on breaker or other security problems including dynamic strength. An appropriate consideration is required to select a right MCCB for an adverse environmental stress such as this one. Moreover, this stress may incur from vibration during transportation, magnetic impulse while manipulating a switch or may be affected by equipment in surrounding area.

There is a standard call [Vibration Testing Method for Small Electric Appliances] for vibration and impulse test for electric equipment and the seismic and endurance tests of Molded Case Circuit Breaker are conducted in accordance with this standard, considering the circumstance mentioned above.

Vibration

The magnitude of vibration is measured by double amplitude and frequency with the following equation with accelerator.

$$\alpha g = 0.002 \times \text{frequency(Hz)} \times \text{double amplitude (mm)}$$

* αg : multiple of gravitational acceleration ($g=9.8\text{m/sec}^2$)

There are three types of vibration tests including resonance test, vibration endurance test, and malfunction test as described below.

1) Resonant Test

Alter the frequency of sinusoidal wave within the range of 0~55Hz gradually with 0.5~1mm of double amplitude applied to see if there is any occurrence of vibration on a specific part of MCCB.

2) Vibration Endurance Test

A sinusoidal wave with double amplitude of 0.5~1mm and frequency of 55Hz(resonant frequency obtained in previous clause if there is a resonant point) is manually created to check the operational status.

3) Malfunction Test

Apply vibration for 10 minutes for each condition of altering double amplitude and frequency to check if there is any malfunction in MCCB.

Impulse

The magnitude of impulse is denoted by the multiple of gravitational acceleration imposed on the equipment and part. The test is conducted through a drop impulse test.

Impact of High Frequency

In case of high frequency current, you are required to reduce the rated current of the breaker with a thermal magnetic trip element embedded due to heat incurred by the skin effect of conductor and/or core loss of structure. The reduction rate varies according to the Frame Size and rated current and decreases down to 70~80% at 400Hz. In addition, the core loss decreases attractive force, which leads to increase of instantaneous trip current.

* Core loss: It refers to the electrical loss in a transformer caused by magnetization of the core that changes over time and is categorized into hysteresis loss and eddy current loss.

* Hysteresis loss: It takes up the majority portion of no-load loss of electric equipment and is calculated like this.

$$P_h = \sigma f B_m n$$

B_m : maximum value of magnetic flux density, n : constant(1.6~2.0), f : frequency, σ : hysteresis constant

* Eddy current: It refers to an induced electric current formed within the body of a conductor when it moves through a non-uniform or changing magnetic field. The eddy current that incurs at winding of transformer or core is considered as one of the transformer losses as a part of exciting current. It is also called 'eddy current loss'.

Use Environment with Vibration and Impulse Applied

[Table of Seismic Performance and Internal Impulse Performance]

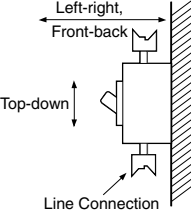
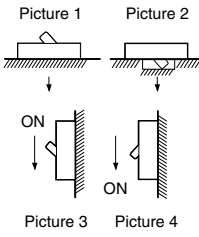
		Test	Internal Impulse
Test Condition	Mounting	<ul style="list-style-type: none"> Vertical mounting Top-down, Left-right, Front-back 	<ul style="list-style-type: none"> Picture 1, 2, 3, 4 (→ represents the direction of drop) 
	Status of MCCB	(1) Non-conduction (ON or OFF status) (2) Status where rated current is conducted until the temperature of MCCB becomes constant and keeps being conducted	Non-conduction (ON or OFF status)
Test Result	Judgment Condition	<ul style="list-style-type: none"> If it is ON, it should not be OFF If it is OFF, it should not be ON No abnormal status such as damage, transformation, or annealing of nut part Characteristics of switch and trip after the test must be normal 	

Catalogue numbers

ABN-Type



Type	Item Code	Description	Pole	Icu		Size(mm)			Page
				220V	460V	W	H	D	
ABN52c	0128002300	ABN52c 15A EXP	2P	30kA	14kA	50	130	60	30
	0128002400	ABN52c 20A EXP							
	0128002500	ABN52c 30A EXP							
	0128002600	ABN52c 40A EXP							
	0128002700	ABN52c 50A EXP							
ABN53c	0129006400	ABN53c 15A EXP	3P	30kA	14kA	75	130	60	30
	0129006500	ABN53c 20A EXP							
	0129006600	ABN53c 30A EXP							
	0129006700	ABN53c 40A EXP							
	0129006800	ABN53c 50A EXP							
ABN54c	0132004800	ABN54c 15A EXP	4P	30kA	14kA	100	130	60	30
	0132004900	ABN54c 20A EXP							
	0132005000	ABN54c 30A EXP							
	0132005100	ABN54c 40A EXP							
	0132005200	ABN54c 50A EXP							
ABN62c	0128002800	ABN62c 15A EXP	2P	30kA	14kA	50	130	60	32
	0128002900	ABN62c 20A EXP							
	0128003000	ABN62c 30A EXP							
	0128003100	ABN62c 40A EXP							
	0128003200	ABN62c 50A EXP							
ABN63c	0129006900	ABN63c 15A EXP	3P	30kA	14kA	75	130	60	32
	0129007000	ABN63c 20A EXP							
	0129007100	ABN63c 30A EXP							
	0129007200	ABN63c 40A EXP							
	0129007300	ABN63c 50A EXP							
ABN64c	0132005300	ABN64c 15A EXP	4P	30kA	14kA	100	130	60	32
	0132005400	ABN64c 20A EXP							
	0132005500	ABN64c 30A EXP							
	0132005600	ABN64c 40A EXP							
	0132005700	ABN64c 50A EXP							
ABN102c	0130002700	ABN102c 15A EXP	2P	35kA	18kA	50	130	60	34
	0130002800	ABN102c 20A EXP							
	0130002900	ABN102c 30A EXP							
	0130003000	ABN102c 40A EXP							
	0130003100	ABN102c 50A EXP							
	0130003200	ABN102c 60A EXP							
	0130003300	ABN102c 75A EXP							
	0130003400	ABN102c 100A EXP							
ABN103c	0131007700	ABN103c 15A EXP	3P	35kA	18kA	75	130	60	34
	0131007800	ABN103c 20A EXP							
	0131007900	ABN103c 30A EXP							
	0131008000	ABN103c 40A EXP							
	0131008100	ABN103c 50A EXP							
	0131008200	ABN103c 60A EXP							
	0131008300	ABN103c 75A EXP							
	0131008400	ABN103c 100A EXP							

ABN-Type



Type	Item Code	Description	Pole	Icu		Size(mm)			Page
				220V	460V	W	H	D	
ABN104c	0132005900	ABN104c 15A EXP	4P	35kA	18kA	100	130	60	34
	0132006000	ABN104c 20A EXP							
	0132006100	ABN104c 30A EXP							
	0132006200	ABN104c 40A EXP							
	0132006300	ABN104c 50A EXP							
	0132006400	ABN104c 60A EXP							
	0132006500	ABN104c 75A EXP							
ABN202c	0136001500	ABN202c 100A EXP	2P	65kA	26kA	105	165	60	38
	0136001600	ABN202c 125A EXP							
	0136001700	ABN202c 150A EXP							
	0136001800	ABN202c 175A EXP							
	0136001900	ABN202c 200A EXP							
	0136002000	ABN202c 225A EXP							
	0136002100	ABN202c 250A EXP							
ABN203c	0137005300	ABN203c 100A EXP	3P	65kA	26kA	105	165	60	38
	0137005400	ABN203c 125A EXP							
	0137005500	ABN203c 150A EXP							
	0137005600	ABN203c 175A EXP							
	0137005700	ABN203c 200A EXP							
	0137005800	ABN203c 225A EXP							
ABN204c	0138002200	ABN204c 100A EXP	4P	65kA	26kA	140	165	60	38
	0138002300	ABN204c 125A EXP							
	0138002400	ABN204c 150A EXP							
	0138002500	ABN204c 175A EXP							
	0138002600	ABN204c 200A EXP							
	0138002700	ABN204c 225A EXP							
	0138002800	ABN204c 250A EXP							
ABN402c	0164000100	ABN402c 250A EXP	2P	50kA	37kA	140	257	109	40
	0164000200	ABN402c 300A EXP							
	0164000300	ABN402c 350A EXP							
	0164000400	ABN402c 400A EXP							
ABN403c	0164000500	ABN403c 250A EXP	3P	50kA	37kA	140	257	109	40
	0164000600	ABN403c 300A EXP							
	0164000700	ABN403c 350A EXP							
	0164000800	ABN403c 400A EXP							
ABN404c	0164000900	ABN404c 250A EXP	4P	50kA	37kA	180	257	109	40
	0164001000	ABN404c 300A EXP							
	0164001100	ABN404c 350A EXP							
	0164001200	ABN404c 400A EXP							
ABN802c	0166000100	ABN802c 700A EXP	2P	50kA	37kA	210	280	109	42
	0166000200	ABN802c 800A EXP							
ABN803c	0166000300	ABN803c 700A EXP	3P	50kA	37kA	210	280	109	42
	0166000400	ABN803c 800A EXP							
ABN804c	0166000500	ABN804c 700A EXP	4P	50kA	37kA	280	280	109	42
	0166000600	ABN804c 800A EXP							

Catalogue numbers

ABS-Type



Type	Item Code	Description	Pole	Icu		Size(mm)			Page
				220V	460V	W	H	D	
ABS32c	0128001600	ABS32c 3A EXP	2P	30(25)kA	14(10)kA	50	130	60	28
	0128001700	ABS32c 5A EXP							
	0128001800	ABS32c 10A EXP							
	0128001900	ABS32c 15A EXP							
	0128002000	ABS32c 20A EXP							
	0128002100	ABS32c 30A EXP							
ABS33c	0129001600	ABS33c 3A EXP	3P	30(25)kA	14(10)kA	75	130	60	28
	0129001700	ABS33c 5A EXP							
	0129001800	ABS33c 10A EXP							
	0129001900	ABS33c 15A EXP							
	0129002000	ABS33c 20A EXP							
	0129002100	ABS33c 30A EXP							
ABS52c	0130001300	ABS52c 15A EXP	2P	35kA	18kA	50	130	60	30
	0130001400	ABS52c 20A EXP							
	0130001500	ABS52c 30A EXP							
	0130001600	ABS52c 40A EXP							
	0130001700	ABS52c 50A EXP							
ABS53c	0131001300	ABS53c 15A EXP	3P	35kA	18kA	75	130	60	30
	0131001400	ABS53c 20A EXP							
	0131001500	ABS53c 30A EXP							
	0131001600	ABS53c 40A EXP							
	0131001700	ABS53c 50A EXP							
ABS54c	0132001300	ABS54c 15A EXP	4P	35kA	18kA	100	130	60	30
	0132001400	ABS54c 20A EXP							
	0132001500	ABS54c 30A EXP							
	0132001600	ABS54c 40A EXP							
	0132001700	ABS54c 50A EXP							
ABS62c	0130002000	ABS62c 15A EXP	2P	35kA	18kA	50	130	60	32
	0130002100	ABS62c 20A EXP							
	0130002200	ABS62c 30A EXP							
	0130002300	ABS62c 40A EXP							
	0130002400	ABS62c 50A EXP							
	0130002500	ABS62c 60A EXP							
ABS63c	0131002000	ABS63c 15A EXP	3P	35kA	18kA	75	130	60	32
	0131002100	ABS63c 20A EXP							
	0131002200	ABS63c 30A EXP							
	0131002300	ABS63c 40A EXP							
	0131002400	ABS63c 50A EXP							
	0131002500	ABS63c 60A EXP							
ABS64c	0132002000	ABS64c 15A EXP	4P	35kA	18kA	100	130	60	32
	0132002100	ABS64c 20A EXP							
	0132002200	ABS64c 30A EXP							
	0132002300	ABS64c 40A EXP							
	0132002400	ABS64c 50A EXP							
	0132002500	ABS64c 60A EXP							
ABS102c	0133000100	ABS102c 15A EXP	2P	85kA	37kA	60	155	60	36
	0133000200	ABS102c 20A EXP							
	0133000300	ABS102c 30A EXP							
	0133000400	ABS102c 40A EXP							
	0133000500	ABS102c 50A EXP							
	0133000600	ABS102c 60A EXP							
	0133000700	ABS102c 75A EXP							
	0133000800	ABS102c 100A EXP							
0133000900	ABS102c 125A EXP								
ABS103c	0134000100	ABS103c 15A EXP	3P	85kA	37kA	90	155	60	36
	0134000200	ABS103c 20A EXP							

ABS-Type



Type	Item Code	Description	Pole	Icu		Size(mm)			Page
				220V	460V	W	H	D	
ABS103c	0134000300	ABS103c 30A EXP	3P	85kA	37kA	90	155	60	36
	0134000400	ABS103c 40A EXP							
	0134000500	ABS103c 50A EXP							
	0134000600	ABS103c 60A EXP							
	0134000700	ABS103c 75A EXP							
	0134000800	ABS103c 100A EXP							
ABS104c	0134000900	ABS103c 125A EXP	4P	85kA	37kA	120	155	60	36
	0135000100	ABS104c 15A EXP							
	0135000200	ABS104c 20A EXP							
	0135000300	ABS104c 30A EXP							
	0135000400	ABS104c 40A EXP							
	0135000500	ABS104c 50A EXP							
	0135000600	ABS104c 60A EXP							
	0135000700	ABS104c 75A EXP							
ABS202c	0135000800	ABS104c 100A EXP	2P	85kA	37kA	105	165	60	38
	0135000900	ABS104c 125A EXP							
	0136000100	ABS202c 100A EXP							
	0136000200	ABS202c 125A EXP							
	0136000300	ABS202c 150A EXP							
	0136000400	ABS202c 175A EXP							
	0136000500	ABS202c 200A EXP							
ABS203c	0136000600	ABS202c 225A EXP	3P	85kA	37kA	105	165	60	38
	0136000700	ABS202c 250A EXP							
	0137000100	ABS203c 100A EXP							
	0137000200	ABS203c 125A EXP							
	0137000300	ABS203c 150A EXP							
	0137000400	ABS203c 175A EXP							
	0137000500	ABS203c 200A EXP							
ABS204c	0137000600	ABS203c 225A EXP	4P	85kA	37kA	140	165	60	38
	0137000700	ABS203c 250A EXP							
	0138000100	ABS204c 100A EXP							
	0138000200	ABS204c 125A EXP							
	0138000300	ABS204c 150A EXP							
	0138000400	ABS204c 175A EXP							
	0138000500	ABS204c 200A EXP							
ABS402c	0138000600	ABS204c 225A EXP	2P	75kA	50kA	140	257	109	40
	0138000700	ABS204c 250A EXP							
	0164001300	ABS402c 250A EXP							
	0164001400	ABS402c 300A EXP							
ABS403c	0164001500	ABS402c 350A EXP	3P	75kA	50kA	140	257	109	40
	0164001600	ABS402c 400A EXP							
	0164001700	ABS403c 250A EXP							
	0164001800	ABS403c 300A EXP							
ABS404c	0164001900	ABS403c 350A EXP	4P	75kA	50kA	180	257	109	40
	0164002000	ABS403c 400A EXP							
	0164002100	ABS404c 250A EXP							
	0164002200	ABS404c 300A EXP							
ABS802c	0164002300	ABS404c 350A EXP	2P	85kA	65kA	210	280	109	42
	0164002400	ABS404c 400A EXP							
ABS803c	0166000700	ABS802c 700A EXP	3P	85kA	65kA	210	280	109	42
	0166000800	ABS802c 800A EXP							
ABS804c	0166000900	ABS803c 700A EXP	4P	85kA	65kA	280	280	109	42
	0166001000	ABS803c 800A EXP							
	0166001100	ABS804c 700A EXP							
	0166001200	ABS804c 800A EXP							

Catalogue numbers

ABH-Type



Type	Item Code	Description	Pole	Icu		Size(mm)			Page
				220V	460V	W	H	D	
ABH52c	0133001000	ABH52c 15A EXP	2P	85kA	37kA	60	155	60	30
	0133001100	ABH52c 20A EXP							
	0133001200	ABH52c 30A EXP							
	0133001300	ABH52c 40A EXP							
	0133001400	ABH52c 50A EXP							
ABH53c	0134001000	ABH53c 15A EXP	3P	85kA	37kA	90	155	60	30
	0134001100	ABH53c 20A EXP							
	0134001200	ABH53c 30A EXP							
	0134001300	ABH53c 40A EXP							
	0134001400	ABH53c 50A EXP							
ABH54c	0135001000	ABH54c 15A EXP	4P	85kA	37kA	120	155	60	30
	0135001100	ABH54c 20A EXP							
	0135001200	ABH54c 30A EXP							
	0135001300	ABH54c 40A EXP							
	0135001400	ABH54c 50A EXP							
ABH102c	0133001500	ABH102c 15A EXP	2P	100kA	50kA	60	155	60	36
	0133001600	ABH102c 20A EXP							
	0133001700	ABH102c 30A EXP							
	0133001800	ABH102c 40A EXP							
	0133001900	ABH102c 50A EXP							
	0133002000	ABH102c 60A EXP							
	0133002100	ABH102c 75A EXP							
	0133002200	ABH102c 100A EXP							
	0133002300	ABH102c 125A EXP							
ABH103c	0134001500	ABH103c 15A EXP	3P	100kA	50kA	90	155	60	36
	0134001600	ABH103c 20A EXP							
	0134001700	ABH103c 30A EXP							
	0134001800	ABH103c 40A EXP							
	0134001900	ABH103c 50A EXP							
	0134002000	ABH103c 60A EXP							
	0134002100	ABH103c 75A EXP							
	0134002200	ABH103c 100A EXP							
	0134002300	ABH103c 125A EXP							
ABH104c	0135001500	ABH104c 15A EXP	4P	100kA	50kA	120	155	60	36
	0135001600	ABH104c 20A EXP							
	0135001700	ABH104c 30A EXP							
	0135001800	ABH104c 40A EXP							
	0135001900	ABH104c 50A EXP							
	0135002000	ABH104c 60A EXP							
	0135002100	ABH104c 75A EXP							
	0135002200	ABH104c 100A EXP							
	0135002300	ABH104c 125A EXP							

ABH-Type



Type	Item Code	Description	Pole	Icu		Size(mm)			Page
				220V	460V	W	H	D	
ABH202c	0139000100	ABH202c 100A EXP	2P	100kA	50kA	105	165	60	38
	0139000200	ABH202c 125A EXP							
	0139000300	ABH202c 150A EXP							
	0139000400	ABH202c 175A EXP							
	0139000500	ABH202c 200A EXP							
	0139000600	ABH202c 225A EXP							
	0139000700	ABH202c 250A EXP							
ABH203c	0140000100	ABH203c 100A EXP	3P	100kA	50kA	105	165	60	38
	0140000200	ABH203c 125A EXP							
	0140000300	ABH203c 150A EXP							
	0140000400	ABH203c 175A EXP							
	0140000500	ABH203c 200A EXP							
	0140000600	ABH203c 225A EXP							
	0140000700	ABH203c 250A EXP							
ABH204c	0141000100	ABH204c 100A EXP	4P	100kA	50kA	140	165	60	38
	0141000200	ABH204c 125A EXP							
	0141000300	ABH204c 150A EXP							
	0141000400	ABH204c 175A EXP							
	0141000500	ABH204c 200A EXP							
	0141000600	ABH204c 225A EXP							
	0141000700	ABH204c 250A EXP							
ABH402c	0164002500	ABH402c 250A EXP	2P	85kA	65kA	140	257	109	40
	0164002600	ABH402c 300A EXP							
	0164002700	ABH402c 350A EXP							
	0164002800	ABH402c 400A EXP							
ABH403c	0164002900	ABH403c 250A EXP	3P	85kA	65kA	140	257	109	40
	0164003000	ABH403c 300A EXP							
	0164003100	ABH403c 350A EXP							
	0164003200	ABH403c 400A EXP							
ABH404c	0164003300	ABH404c 250A EXP	4P	85kA	65kA	180	257	109	40
	0164003400	ABH404c 300A EXP							
	0164003500	ABH404c 350A EXP							
	0164003600	ABH404c 400A EXP							

Catalogue numbers

ABL-Type



Type	Item Code	Description	Pole	Icu		Size(mm)			Page
				220V	460V	W	H	D	
ABL402c	0164003700	ABL402c 250A EXP	2P	125kA	85kA	140	257	109	40
	0164003800	ABL402c 300A EXP							
	0164003900	ABL402c 350A EXP							
	0164004000	ABL402c 400A EXP							
ABL403c	0164004100	ABL403c 250A EXP	3P	125kA	85kA	140	257	109	40
	0164004200	ABL403c 300A EXP							
	0164004300	ABL403c 350A EXP							
	0164004400	ABL403c 400A EXP							
ABL404c	0164004500	ABL404c 250A EXP	4P	125kA	85kA	180	257	109	40
	0164004600	ABL404c 300A EXP							
	0164004700	ABL404c 350A EXP							
	0164004800	ABL404c 400A EXP							
ABL802c	0166001300	ABL802c 700A EXP	2P	125kA	85kA	210	280	109	42
	0166001400	ABL802c 800A EXP							
ABL803c	0166001500	ABL803c 700A EXP	3P	125kA	85kA	210	280	109	42
	0166001600	ABL803c 800A EXP							
ABL804c	0166001700	ABL804c 700A EXP	4P	125kA	85kA	280	280	109	42
	0166001800	ABL804c 800A EXP							

EBN-Type



Type	Item Code	Description	Pole	Icu		Size(mm)			Page
				220V	460V	W	H	D	
EBN52c	0142005500	EBN52c 15A 30mA EXP	2P	30kA	14kA	75	130	60	46
	0142005600	EBN52c 20A 30mA EXP							
	0142005700	EBN52c 30A 30mA EXP							
	0142005800	EBN52c 40A 30mA EXP							
	0142005900	EBN52c 50A 30mA EXP							
	0142006000	EBN52c 15A 100/200/500mA EXP							
	0142006100	EBN52c 20A 100/200/500mA EXP							
	0142006200	EBN52c 30A 100/200/500mA EXP							
EBN53c	0142006300	EBN52c 40A 100/200/500mA EXP	3P	30kA	14kA	75	130	60	46
	0142006400	EBN52c 50A 100/200/500mA EXP							
	0142006500	EBN53c 15A 30mA EXP							
	0142006600	EBN53c 20A 30mA EXP							
	0142006700	EBN53c 30A 30mA EXP							
	0142006800	EBN53c 40A 30mA EXP							
	0142006900	EBN53c 50A 30mA EXP							
	0142007000	EBN53c 15A 100/200/500mA EXP							
	0142007100	EBN53c 20A 100/200/500mA EXP							
	0142007200	EBN53c 30A 100/200/500mA EXP							
EBN63c	0142007300	EBN53c 40A 100/200/500mA EXP	3P	30kA	14kA	75	130	60	48
	0142007400	EBN53c 50A 100/200/500mA EXP							
EBN102c	0142007500	EBN63c 60A 30mA EXP	2P	35kA	18kA	50	130	60	50
	0142007600	EBN63c 60A 100/200/500mA EXP							
	0143008900	EBN102c 15A 30mA EXP							
	0143009000	EBN102c 20A 30mA EXP							
	0143009100	EBN102c 30A 30mA EXP							
	0143009200	EBN102c 40A 30mA EXP							
	0143009300	EBN102c 50A 30mA EXP							
	0143009400	EBN102c 60A 30mA EXP							
	0143009500	EBN102c 75A 30mA EXP							
	0143009600	EBN102c 100A 30mA EXP							
	0143009700	EBN102c 15A 100/200/500mA EXP							
	0143009800	EBN102c 20A 100/200/500mA EXP							
	0143009900	EBN102c 30A 100/200/500mA EXP							
	0143010000	EBN102c 40A 100/200/500mA EXP							
	0143010100	EBN102c 50A 100/200/500mA EXP							
	0143010200	EBN102c 60A 100/200/500mA EXP							
EBN103c	0143010300	EBN102c 75A 100/200/500mA EXP	3P	35kA	18kA	75	130	60	50
	0143010400	EBN102c 100A 100/200/500mA EXP							
	0143010500	EBN103c 15A 30mA EXP							
	0143010600	EBN103c 20A 30mA EXP							
	0143010700	EBN103c 30A 30mA EXP							
	0143010800	EBN103c 40A 30mA EXP							
	0143010900	EBN103c 50A 30mA EXP							
0143011000	EBN103c 60A 30mA EXP								
	0143011100	EBN103c 75A 30mA EXP							

Catalogue numbers

EBN-Type



Type	Item Code	Description	Pole	Icu		Size(mm)			Page
				220V	460V	W	H	D	
EBN103c	0143011200	EBN103c 100A 30mA EXP	3P	35kA	18kA	75	130	60	50
	0143011300	EBN103c 15A 100/200/500mA EXP							
	0143011400	EBN103c 20A 100/200/500mA EXP							
	0143011500	EBN103c 30A 100/200/500mA EXP							
	0143011600	EBN103c 40A 100/200/500mA EXP							
	0143011700	EBN103c 50A 100/200/500mA EXP							
	0143011800	EBN103c 60A 100/200/500mA EXP							
	0143011900	EBN103c 75A 100/200/500mA EXP							
	0143012000	EBN103c 100A 100/200/500mA EXP							
EBN104c	0143012100	EBN104c 15A 30mA EXP	4P	35kA	18kA	100	130	60	50
	0143012200	EBN104c 20A 30mA EXP							
	0143012300	EBN104c 30A 30mA EXP							
	0143012400	EBN104c 40A 30mA EXP							
	0143012500	EBN104c 50A 30mA EXP							
	0143012600	EBN104c 60A 30mA EXP							
	0143012700	EBN104c 75A 30mA EXP							
	0143012800	EBN104c 100A 30mA EXP							
	0143012900	EBN104c 15A 100/200/500mA EXP							
	0143013000	EBN104c 20A 100/200/500mA EXP							
	0143013100	EBN104c 30A 100/200/500mA EXP							
	0143013200	EBN104c 40A 100/200/500mA EXP							
	0143013300	EBN104c 50A 100/200/500mA EXP							
	0143013400	EBN104c 60A 100/200/500mA EXP							
	0143013500	EBN104c 75A 100/200/500mA EXP							
	0143013600	EBN104c 100A 100/200/500mA EXP							
EBN202c	0145005700	EBN202c 100A 30mA EXP	2P	65kA	26kA	105	165	60	54
	0145005800	EBN202c 125A 30mA EXP							
	0145005900	EBN202c 150A 30mA EXP							
	0145006000	EBN202c 175A 30mA EXP							
	0145006100	EBN202c 200A 30mA EXP							
	0145006200	EBN202c 225A 30mA EXP							
	0145006300	EBN202c 250A 30mA EXP							
	0145006400	EBN202c 100A 100/200/500mA EXP							
	0145006500	EBN202c 125A 100/200/500mA EXP							
	0145006600	EBN202c 150A 100/200/500mA EXP							
	0145006700	EBN202c 175A 100/200/500mA EXP							
	0145006800	EBN202c 200A 100/200/500mA EXP							
	0145006900	EBN202c 225A 100/200/500mA EXP							
	0145007000	EBN202c 250A 100/200/500mA EXP							



Type	Item Code	Description	Pole	Icu		Size(mm)			Page
				220V	460V	W	H	D	
EBN203c	0145007100	EBN203c 100A 30mA EXP	3P	65kA	26kA	105	165	60	54
	0145007200	EBN203c 125A 30mA EXP							
	0145007300	EBN203c 150A 30mA EXP							
	0145007400	EBN203c 175A 30mA EXP							
	0145007500	EBN203c 200A 30mA EXP							
	0145007600	EBN203c 225A 30mA EXP							
	0145007700	EBN203c 250A 30mA EXP							
	0145007800	EBN203c 100A 100/200/500mA EXP							
	0145007900	EBN203c 125A 100/200/500mA EXP							
	0145008000	EBN203c 150A 100/200/500mA EXP							
	0145008100	EBN203c 175A 100/200/500mA EXP							
	0145008200	EBN203c 200A 100/200/500mA EXP							
	0145008300	EBN203c 225A 100/200/500mA EXP							
	0145008400	EBN203c 250A 100/200/500mA EXP							
EBN403c	0167000100	EBN403c 250A 30mA EXP	3P	50kA	37kA	104	257	109	56
	0167000200	EBN403c 300A 30mA EXP							
	0167000300	EBN403c 350A 30mA EXP							
	0167000400	EBN403c 400A 30mA EXP							
	0167000500	EBN403c 250A 100/200/500mA EXP							
	0167000600	EBN403c 300A 100/200/500mA EXP							
	0167000700	EBN403c 350A 100/200/500mA EXP							
	0167000800	EBN403c 400A 100/200/500mA EXP							
EBN404c	0167000900	EBN404c 250A 30mA EXP	4P	50kA	37kA	184	257	109	56
	0167001000	EBN404c 300A 30mA EXP							
	0167001100	EBN404c 350A 30mA EXP							
	0167001200	EBN404c 400A 30mA EXP							
	0167001300	EBN404c 250A 100/200/500mA EXP							
	0167001400	EBN404c 300A 100/200/500mA EXP							
	0167001500	EBN404c 350A 100/200/500mA EXP							
	0167001600	EBN404c 400A 100/200/500mA EXP							
EBN803c	0169000100	EBN803c 700A 30mA EXP	3P	50kA	37kA	210	280	109	58
	0169000200	EBN803c 800A 30mA EXP							
	0169000300	EBN803c 700A 100/200/500mA EXP							
	0169000400	EBN803c 800A 100/200/500mA EXP							

Catalogue numbers

EBS-Type



Type	Item Code	Description	Pole	Icu		Size(mm)			Page
				220V	460V	W	H	D	
EBS33c	0142003400	EBS33c 15A 30mA EXP	3P	30kA	14kA	75	130	60	44
	0142003500	EBS33c 20A 30mA EXP							
	0142003600	EBS33c 30A 30mA EXP							
	0142004000	EBS33c 15A 100/200/500mA EXP							
	0142004100	EBS33c 20A 100/200/500mA EXP							
	0142004200	EBS33c 30A 100/200/500mA EXP							
EBS53c	0143004100	EBS53c 5A 30mA EXP	3P	35kA	18kA	75	130	60	46
	0143004200	EBS53c 10A 30mA EXP							
	0143004300	EBS53c 15A 30mA EXP							
	0143004400	EBS53c 20A 30mA EXP							
	0143004500	EBS53c 30A 30mA EXP							
	0143004600	EBS53c 40A 30mA EXP							
	0143004700	EBS53c 50A 30mA EXP							
	0143004800	EBS53c 5A 100/200/500mA EXP							
	0143004900	EBS53c 10A 100/200/500mA EXP							
	0143005000	EBS53c 15A 100/200/500mA EXP							
	0143005100	EBS53c 20A 100/200/500mA EXP							
	0143005200	EBS53c 30A 100/200/500mA EXP							
	0143005300	EBS53c 40A 100/200/500mA EXP							
	0143005400	EBS53c 50A 100/200/500mA EXP							
EBS54c	0143007500	EBS54c 15A 30mA EXP	4P	35kA	18kA	100	130	60	46
	0143007600	EBS54c 20A 30mA EXP							
	0143007700	EBS54c 30A 30mA EXP							
	0143007800	EBS54c 40A 30mA EXP							
	0143007900	EBS54c 50A 30mA EXP							
	0143008200	EBS54c 15A 100/200/500mA EXP							
	0143008300	EBS54c 20A 100/200/500mA EXP							
	0143008400	EBS54c 30A 100/200/500mA EXP							
	0143008500	EBS54c 40A 100/200/500mA EXP							
	0143008600	EBS54c 50A 100/200/500mA EXP							
EBS63c	0143005500	EBS63c 60A 30mA EXP	3P	35kA	18kA	75	130	60	48
	0143005600	EBS63c 60A 100/200/500mA EXP							
EBS64c	0143008700	EBS64c 60A 30mA EXP	4P	35kA	18kA	100	130	60	48
	0143008800	EBS64c 60A 100/200/500mA EXP							
EBS103c	0144000100	EBS103c 15A 30mA EXP	3P	85kA	37kA	90	155	60	52
	0144000200	EBS103c 20A 30mA EXP							
	0144000300	EBS103c 30A 30mA EXP							
	0144000400	EBS103c 40A 30mA EXP							
	0144000500	EBS103c 50A 30mA EXP							
	0144000600	EBS103c 60A 30mA EXP							
	0144000700	EBS103c 75A 30mA EXP							
	0144000800	EBS103c 100A 30mA EXP							
0144000900	EBS103c 125A 30mA EXP								



Type	Item Code	Description	Pole	Icu		Size(mm)			Page
				220V	460V	W	H	D	
EBS103c	0144001000	EBS103c 15A 100/200/500mA EXP	3P	85kA	37kA	90	155	60	52
	0144001100	EBS103c 20A 100/200/500mA EXP							
	0144001200	EBS103c 30A 100/200/500mA EXP							
	0144001300	EBS103c 40A 100/200/500mA EXP							
	0144001400	EBS103c 50A 100/200/500mA EXP							
	0144001500	EBS103c 60A 100/200/500mA EXP							
	0144001600	EBS103c 75A 100/200/500mA EXP							
	0144001700	EBS103c 100A 100/200/500mA EXP							
	0144001800	EBS103c 125A 100/200/500mA EXP							
EBS104c	0144004700	EBS104c 15A 30mA EXP	4P	85kA	37kA	120	155	60	52
	0144004800	EBS104c 20A 30mA EXP							
	0144004900	EBS104c 30A 30mA EXP							
	0144005000	EBS104c 40A 30mA EXP							
	0144005100	EBS104c 50A 30mA EXP							
	0144005200	EBS104c 60A 30mA EXP							
	0144005300	EBS104c 75A 30mA EXP							
	0144005400	EBS104c 100A 30mA EXP							
	0144005500	EBS104c 125A 30mA EXP							
	0144005600	EBS104c 15A 100/200/500mA EXP							
	0144005700	EBS104c 20A 100/200/500mA EXP							
	0144005800	EBS104c 30A 100/200/500mA EXP							
	0144005900	EBS104c 40A 100/200/500mA EXP							
	0144006000	EBS104c 50A 100/200/500mA EXP							
	0144006100	EBS104c 60A 100/200/500mA EXP							
	0144006200	EBS104c 75A 100/200/500mA EXP							
	0144006300	EBS104c 100A 100/200/500mA EXP							
	0144006400	EBS104c 125A 100/200/500mA EXP							
EBS203c	0145001500	EBS203c 100A 30mA EXP	3P	85kA	37kA	105	165	60	54
	0145001600	EBS203c 125A 30mA EXP							
	0145001700	EBS203c 150A 30mA EXP							
	0145001800	EBS203c 175A 30mA EXP							
	0145001900	EBS203c 200A 30mA EXP							
	0145002000	EBS203c 225A 30mA EXP							
	0145002100	EBS203c 250A 30mA EXP							
	0145002200	EBS203c 100A 100/200/500mA EXP							
	0145002300	EBS203c 125A 100/200/500mA EXP							
	0145002400	EBS203c 150A 100/200/500mA EXP							
	0145002500	EBS203c 175A 100/200/500mA EXP							
	0145002600	EBS203c 200A 100/200/500mA EXP							
	0145002700	EBS203c 225A 100/200/500mA EXP							
	0145002800	EBS203c 250A 100/200/500mA EXP							

Catalogue numbers

EBS-Type



Type	Item Code	Description	Pole	Icu		Size(mm)			Page
				220V	460V	W	H	D	
EBS204c	0145004300	EBS204c 100A 30mA EXP	4P	85kA	37kA	140	165	60	54
	0145004400	EBS204c 125A 30mA EXP							
	0145004500	EBS204c 150A 30mA EXP							
	0145004600	EBS204c 175A 30mA EXP							
	0145004700	EBS204c 200A 30mA EXP							
	0145004800	EBS204c 225A 30mA EXP							
	0145004900	EBS204c 250A 30mA EXP							
	0145005000	EBS204c 100A 100/200/500mA EXP							
	0145005100	EBS204c 125A 100/200/500mA EXP							
	0145005200	EBS204c 150A 100/200/500mA EXP							
	0145005300	EBS204c 175A 100/200/500mA EXP							
	0145005400	EBS204c 200A 100/200/500mA EXP							
	0145005500	EBS204c 225A 100/200/500mA EXP							
	0145005600	EBS204c 250A 100/200/500mA EXP							
EBS403c	0167001700	EBS403c 250A 30mA EXP	3P	75kA	50kA	140	257	109	56
	0167001800	EBS403c 300A 30mA EXP							
	0167001900	EBS403c 350A 30mA EXP							
	0167002000	EBS403c 400A 30mA EXP							
	0167002100	EBS403c 250A 100/200/500mA EXP							
	0167002200	EBS403c 300A 100/200/500mA EXP							
	0167002300	EBS403c 350A 100/200/500mA EXP							
	0167002400	EBS403c 400A 100/200/500mA EXP							
EBS404c	0167002500	EBS404c 250A 30mA EXP	4P	75kA	50kA	185	257	109	56
	0167002600	EBS404c 300A 30mA EXP							
	0167002700	EBS404c 350A 30mA EXP							
	0167002800	EBS404c 400A 30mA EXP							
	0167002900	EBS404c 250A 100/200/500mA EXP							
	0167003000	EBS404c 300A 100/200/500mA EXP							
	0167003100	EBS404c 350A 100/200/500mA EXP							
	0167003200	EBS404c 400A 100/200/500mA EXP							
EBS803c	0169000500	EBS803c 700A 30mA EXP	3P	85kA	65kA	210	280	109	58
	0169000600	EBS803c 800A 30mA EXP							
	0169000700	EBS803c 700A 100/200/500mA EXP							
	0169000800	EBS803c 800A 100/200/500mA EXP							
		0169000900EBL803c 700A 30mA EXP							
	0169001000	EBL803c 800A 30mA EXP							
	0169001100	EBL803c 700A 100/200/500mA EXP							
	0169001200	EBL803c 800A 100/200/500mA EXP							

EBH-Type



Type	Item Code	Description	Pole	Icu		Size(mm)			Page
				220V	460V	W	H	D	
EBH53c	0144001900	EBH53c 15A 30mA EXP	3P	100kA	50kA	90	155	60	46
	0144002000	EBH53c 20A 30mA EXP							
	0144002100	EBH53c 30A 30mA EXP							
	0144002200	EBH53c 40A 30mA EXP							
	0144002300	EBH53c 50A 30mA EXP							
	0144002400	EBH53c 15A 100/200/500mA EXP							
	0144002500	EBH53c 20A 100/200/500mA EXP							
	0144002600	EBH53c 30A 100/200/500mA EXP							
	0144002700	EBH53c 40A 100/200/500mA EXP							
0144002800	EBH53c 50A 100/200/500mA EXP								
EBH54c	0144006500	EBH54c 15A 30mA EXP	4P	100kA	50kA	120	155	60	46
	0144006600	EBH54c 20A 30mA EXP							
	0144006700	EBH54c 30A 30mA EXP							
	0144006800	EBH54c 40A 30mA EXP							
	0144006900	EBH54c 50A 30mA EXP							
	0144007000	EBH54c 15A 100/200/500mA EXP							
	0144007100	EBH54c 20A 100/200/500mA EXP							
	0144007200	EBH54c 30A 100/200/500mA EXP							
0144007300	EBH54c 40A 100/200/500mA EXP								
0144007400	EBH54c 50A 100/200/500mA EXP								
EBH103c	0144002900	EBH103c 15A 30mA EXP	3P	100kA	50kA	90	155	60	52
	0144003000	EBH103c 20A 30mA EXP							
	0144003100	EBH103c 30A 30mA EXP							
	0144003200	EBH103c 40A 30mA EXP							
	0144003300	EBH103c 50A 30mA EXP							
	0144003400	EBH103c 60A 30mA EXP							
	0144003500	EBH103c 75A 30mA EXP							
	0144003600	EBH103c 100A 30mA EXP							
	0144003700	EBH103c 125A 30mA EXP							
	0144003800	EBH103c 15A 100/200/500mA EXP							
	0144003900	EBH103c 20A 100/200/500mA EXP							
	0144004000	EBH103c 30A 100/200/500mA EXP							
	0144004100	EBH103c 40A 100/200/500mA EXP							
	0144004200	EBH103c 50A 100/200/500mA EXP							
	0144004300	EBH103c 60A 100/200/500mA EXP							
	0144004400	EBH103c 75A 100/200/500mA EXP							
0144004500	EBH103c 100A 100/200/500mA EXP								
0144004600	EBH103c 125A 100/200/500mA EXP								
EBH104c	0144007500	EBH104c 15A 30mA EXP	4P	100kA	50kA	120	155	60	52
	0144007600	EBH104c 20A 30mA EXP							
	0144007700	EBH104c 30A 30mA EXP							
	0144007800	EBH104c 40A 30mA EXP							
	0144007900	EBH104c 50A 30mA EXP							
	0144008000	EBH104c 60A 30mA EXP							
	0144008100	EBH104c 75A 30mA EXP							
	0144008200	EBH104c 100A 30mA EXP							
	0144008300	EBH104c 125A 30mA EXP							
	0144008400	EBH104c 15A 100/200/500mA EXP							
	0144008500	EBH104c 20A 100/200/500mA EXP							
	0144008600	EBH104c 30A 100/200/500mA EXP							
	0144008700	EBH104c 40A 100/200/500mA EXP							

Catalogue numbers

EBH-Type



Type	Item Code	Description	Pole	Icu		Size(mm)			Page
				220V	460V	W	H	D	
EBH104c	0144008800	EBH104c 50A 100/200/500mA EXP	4P	100kA	50kA	120	155	60	52
	0144008900	EBH104c 60A 100/200/500mA EXP							
	0144009000	EBH104c 75A 100/200/500mA EXP							
	0144009100	EBH104c 100A 100/200/500mA EXP							
	0144009200	EBH104c 125A 100/200/500mA EXP							
EBH203c	0146000100	EBH203c 100A 30mA EXP	3P	100kA	50kA	105	165	60	54
	0146000200	EBH203c 125A 30mA EXP							
	0146000300	EBH203c 150A 30mA EXP							
	0146000400	EBH203c 175A 30mA EXP							
	0146000500	EBH203c 200A 30mA EXP							
	0146000600	EBH203c 225A 30mA EXP							
	0146000700	EBH203c 250A 30mA EXP							
	0146000800	EBH203c 100A 100/200/500mA EXP							
	0146000900	EBH203c 125A 100/200/500mA EXP							
	0146001000	EBH203c 150A 100/200/500mA EXP							
	0146001100	EBH203c 175A 100/200/500mA EXP							
	0146001200	EBH203c 200A 100/200/500mA EXP							
	0146001300	EBH203c 225A 100/200/500mA EXP							
	0146001400	EBH203c 250A 100/200/500mA EXP							
EBH204c	0146001500	EBH204c 100A 30mA EXP	4P	100kA	50kA	140	165	60	54
	0146001600	EBH204c 125A 30mA EXP							
	0146001700	EBH204c 150A 30mA EXP							
	0146001800	EBH204c 175A 30mA EXP							
	0146001900	EBH204c 200A 30mA EXP							
	0146002000	EBH204c 225A 30mA EXP							
	0146002100	EBH204c 250A 30mA EXP							
	0146002200	EBH204c 100A 100/200/500mA EXP							
	0146002300	EBH204c 125A 100/200/500mA EXP							
	0146002400	EBH204c 150A 100/200/500mA EXP							
	0146002500	EBH204c 175A 100/200/500mA EXP							
	0146002600	EBH204c 200A 100/200/500mA EXP							
	0146002700	EBH204c 225A 100/200/500mA EXP							
	0146002800	EBH204c 250A 100/200/500mA EXP							
EBH403c	0167003300	EBH403c 250A 30mA EXP	3P	85kA	65kA	104	257	109	56
	0167003400	EBH403c 300A 30mA EXP							
	0167003500	EBH403c 350A 30mA EXP							
	0167003600	EBH403c 400A 30mA EXP							
	0167003700	EBH403c 250A 100/200/500mA EXP							
	0167003800	EBH403c 300A 100/200/500mA EXP							
	0167003900	EBH403c 350A 100/200/500mA EXP							
	0167004000	EBH403c 400A 100/200/500mA EXP							
EBH404c	0167004100	EBH404c 250A 30mA EXP	4P	85kA	65kA	184	257	109	56
	0167004200	EBH404c 300A 30mA EXP							
	0167004300	EBH404c 350A 30mA EXP							
	0167004400	EBH404c 400A 30mA EXP							
	0167004500	EBH404c 250A 100/200/500mA EXP							
	0167004600	EBH404c 300A 100/200/500mA EXP							
	0167004700	EBH404c 350A 100/200/500mA EXP							
	0167004800	EBH404c 400A 100/200/500mA EXP							

EBL-Type





Type	Item Code	Description	Pole	Icu		Size(mm)			Page
				220V	460V	W	H	D	
EBL403c	0167004900	EBL403c 250A 30mA EXP	3P	125kA	85kA	104	257	109	56
	0167005000	EBL403c 300A 30mA EXP							
	0167005100	EBL403c 350A 30mA EXP							
	0167005200	EBL403c 400A 30mA EXP							
	0167005300	EBL403c 250A 100/200/500mA EXP							
	0167005400	EBL403c 300A 100/200/500mA EXP							
	0167005500	EBL403c 350A 100/200/500mA EXP							
	0167005600	EBL403c 400A 100/200/500mA EXP							
EBL404c	0167005700	EBL404c 250A 30mA EXP	4P	125kA	85kA	184	257	109	56
	0167005800	EBL404c 300A 30mA EXP							
	0167005900	EBL404c 350A 30mA EXP							
	0167006000	EBL404c 400A 30mA EXP							
	0167006100	EBL404c 250A 100/200/500mA EXP							
	0167006200	EBL404c 300A 100/200/500mA EXP							
	0167006300	EBL404c 350A 100/200/500mA EXP							
	0167006400	EBL404c 400A 100/200/500mA EXP							
EBL803c	0169000900	EBL803c 700A 30mA EXP	3P	125kA	85kA	210	280	109	58
	0169001000	EBL803c 800A 30mA EXP							
	0169001100	EBL803c 700A 100/200/500mA EXP							
	0169001200	EBL803c 800A 100/200/500mA EXP							

Catalogue numbers

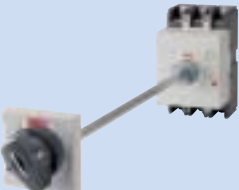

Metasol Accessory (Option)

Rotary handle

Type	Description	Item Code	Description	Page
Direct type 	DH100	83111187002	HANDLE(ACCE),DH100-L, ABE100c	66
		83111187003	HANDLE(ACCE),DH100-R,ABE100c	
		83111187001	HANDLE(ACCE),DH100-S,ABE100c	
	DH125	83111187012	HANDLE(ACCE),DH125-L,ABH125c	
		83111187013	HANDLE(ACCE),DH125-R,ABH125c	
		83111187011	HANDLE(ACCE),DH125-S,ABH125c	
	DH250	83111187022	HANDLE(ACCE),DH250-L,ABH250c	
		83111187023	HANDLE(ACCE),DH250-R,ABH250c	
		83111187021	HANDLE(ACCE),DH250-S,ABH250c	
Direct type (with a the lock) 	DHK100	83111187008	HANDLE(ACCE),DHK100-L,ABE100c	
		83111187009	HANDLE(ACCE),DHK100-R,ABE100c	
		83111187007	HANDLE(ACCE),DHK100-S,ABE100c	
	DHK125	83111187018	HANDLE(ACCE),DHK125-L,ABH125c	
		83111187019	HANDLE(ACCE),DHK125-R,ABH125c	
	DHK250	83111187017	HANDLE(ACCE),DHK125-S,ABH125c	
		83111187028	HANDLE(ACCE),DHK250-L,ABH250c	
		83111187029	HANDLE(ACCE),DHK250-R,ABH250c	
		83111187027	HANDLE(ACCE),DHK250-S,ABH250c	
Extended type 	EH100	83111187005	HANDLE(ACCE),EH100-L,ABE100c	
		83111187006	HANDLE(ACCE),EH100-R,ABE100c	
		83111187004	HANDLE(ACCE),EH100-S,ABE100c	
	EH125	83111187015	HANDLE(ACCE),EH125-L,ABH125c	
		83111187016	HANDLE(ACCE),EH125-R,ABH125c	
		83111187014	HANDLE(ACCE),EH125-S,ABH125c	
	EH250	83111187025	HANDLE(ACCE),EH250-L,ABH250c	
		83111187026	HANDLE(ACCE),EH250-R,ABH250c	
		83111187024	HANDLE(ACCE),EH250-S,ABH250c	

Metasol Accessory (Option)

Terminal covers

Type	Description	Item Code	Description	Page
Short type 	TCS12	64621187204	COVER ASS'Y,TERMINAL,TCS12, ABE100c	67
	TCS13	64621187205	COVER ASS'Y,TERMINAL,TCS13, ABE100c	
	TCS14	64621187206	COVER ASS'Y,TERMINAL,TCS14,ABE100c	
	TCS22	64621187214	COVER ASS'Y,TERMINAL,TCS22,ABH125c	
	TCS23	64621187215	COVER ASS'Y,TERMINAL,TCS23,ABH125c	
	TCS24	64621187216	COVER ASS'Y,TERMINAL,TCS24,ABH125c	
	TCS33	64621187225	COVER ASS'Y,TERMINAL,TCS33,ABH250c	
	TCS34	64621187226	COVER ASS'Y,TERMINAL,TCS34,ABH250c	
Long type 	TCL12	64621187201	COVER ASS'Y,TERMINAL,TCL12,ABE100c	
	TCL13	64621187202	COVER ASS'Y,TERMINAL,TCL13,ABE100c	
	TCL14	64621187203	COVER ASS'Y,TERMINAL,TCL14,ABE100c	
	TCL22	64621187211	COVER ASS'Y,TERMINAL,TCL22,ABH125c	
	TCL23	64621187212	COVER ASS'Y,TERMINAL,TCL23,ABH125c	
	TCL24	64621187213	COVER ASS'Y,TERMINAL,TCL24,ABH125c	
	TCL33	64621187222	COVER ASS'Y,TERMINAL,TCL33,ABH250c	
	TCL34	64621187223	COVER ASS'Y,TERMINAL,TCL34,ABH250c	

Rear connection terminals

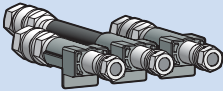
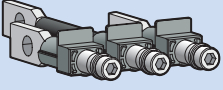
Type	Description	Item Code	Description	Page
Round type 	RTR1-52	83161187011	REAR CONNECTION,RTR1-52, ABE100c	69
	RTR1-53	83161187012	REAR CONNECTION,RTR1-53, ABE100c	
	RTR1-54	83161187013	REAR CONNECTION,RTR1-54, ABE100c	
	RTR1-102	83161187014	REAR CONNECTION,RTR1-102, ABE100c	
	RTR1-103	83161187015	REAR CONNECTION,RTR1-103, ABE100c	
	RTR1-104	83161187016	REAR CONNECTION,RTR1-104, ABE100c	
	RTR2-102	83161187017	REAR CONNECTION,RTR2-102, ABH125c	
	RTR2-103	83161187018	REAR CONNECTION,RTR2-103, ABH125c	
	RTR2-104	83161187019	REAR CONNECTION,RTR2-104, ABH125c	
	RTR3-202	83161187020	REAR CONNECTION,RTR3-202, ABH250c	
	RTR3-203	83161187021	REAR CONNECTION,RTR3-203, ABH250c	
	RTR3-204	83161187022	REAR CONNECTION,RTR3-204, ABH250c	
Bar type 	RTB1-102	83161187001	REAR CONNECTION,RTB1-102, ABE100c	
	RTB1-103	83161187002	REAR CONNECTION,RTB1-103, ABE100c	
	RTB1-104	83161187003	REAR CONNECTION,RTB1-104, ABE100c	
	RTB2-102	83161187004	REAR CONNECTION,RTB2-102, ABH125c	
	RTB2-103	83161187005	REAR CONNECTION,RTB2-103, ABH125c	
	RTB2-104	83161187006	REAR CONNECTION,RTB2-104, ABH125c	
	RTB3-202	83161187007	REAR CONNECTION,RTB3-202, ABH250c	
	RTB3-203	83161187008	REAR CONNECTION,RTB3-203, ABH250c	
RTB3-204	83161187009	REAR CONNECTION,RTB3-204, ABH250c		

Catalogue numbers

Metasol Accessory (Option)

Handle lock

Type	Description	Item Code	Description	Page
Auxiliary switch	AX	83011187001	A,AX,R,W,ABE100c~ABH250c	62
Alarm switch	AL	83011187002	A,AL,R,W,ABE100c~ABH250c	62
		83011187003	A,AX/AL,R,W,ABE100c~ABH250c	
		83011187004	A,AX,T,W,ABE100c~ABH250c	
		83011187005	A,AL,T,W,ABE100c~ABH250c	
		83011187006	A,AX/AL,T,W,ABE100c~ABH250c	
		83011187011	A,AX,R,B,ABE100c~ABH250c	
		83011187012	A,AL,R,B,ABE100c~ABH250c	
		83011187013	A,AX/AL,R,B,ABE100c~ABH250c	
		83011187014	A,AX,T,B,ABE100c~ABH250c	
		83011187015	A,AL,T,B,ABE100c~ABH250c	
Shunt trip	SHT	83011187016	A,AX/AL,T,B,ABE100c~ABH250c	63
		83211187001	T,SHT,T,AC/DC12V,ABE100c~ABH250c	
		83211187002	T,SHT,T,AC/DC24V, ABE100c~ABH250c	
		83211187003	T,SHT,T,AC/DC48V,ABE100c~ABH250c	
		83211187004	T,SHT,T,AC/DC60V,ABE100c~ABH250c	
		83211187005	T,SHT,T,AC/DC100~130V,ABE100c~ABH250c	
		83211187006	T,SHT,T,AC/DC200~250V,ABE100c~ABH250c	
		83211187007	T,SHT,T,AC380~450V,ABE100c~ABH250c	
Undervoltage Release	UVT	83211187008	T,SHT,T,AC440~500V,ABE100c~ABH250c	64
		83211187011	T,UVT,T,AC/DC24V,ABE100c~ABH250c	
		83211187012	T,UVT,T,AC/DC48V,ABE100c~ABH250c	
		83211187013	T,UVT,T,AC/DC100~110V,ABE100c~ABH250c	
		83211187014	T,UVT,T,AC/DC200~220V,ABE100c~ABH250c	
		83211187015	T,UVT,T,AC380~440V,ABE100c~ABH250c	
		83211187016	T,UVT,T,AC440~480V,ABE100c~ABH250c	

Metasol Accessory (Option)

Handle lock

Type	Description	Item Code	Description	Page
Handle lock	HL-100c	83421187001	HANDLE LOCK, ABE100c	
	HL-1250c	83421187002	HANDLE LOCK,ABH125c	
	HL-250c	83421187003	HANDLE LOCK,ABH250c	

Plug-in Devices

Type	Description	Item Code	Description	Page
Normal	PB-A3-FR	54621151101	FRAME ASS'Y,ABE53bP~103bP/S33bP~63bP/H33bP(PB-A3-FR)	70
	PB-C3-FR	54621152101	FRAME ASS'Y,ABS103bP/H53bP~103bP(PB-C3-FR)	
	PB-D3-FR	54621153102	FRAME ASS'Y,JOIN,ABE/S/H203bP(PB-D3-FR)	
	PB-I3-FR	54621131102	FRAME ASS'Y,JOIN,ABE/S/H/L403bP(PB-I3-FR)	
	PB-J3-FR	54621132102	FRAME ASS'Y,JOIN,ABE/S/L603bP~803bP(PB-J3-FR)	
Line-only	PB-A3-FRL	54621151102	FRAME ASS'Y,LINE ONLY, ABE53bP~103bP/S33bP~63bP/H33bP(PB-A3-FRL)	
	PB-C3-FRL	54621152102	FRAME ASS'Y,LINE ONLY,ABS103bP/H53bP~103bP(PB-C3-FRL)	
	PB-D3-FRL	54621153104	FRAME ASS'Y,LINE ONLY,ABE/S/H203bP(PB-D3-FRL)	
	PB-I3-FRL	54621131103	FRAME ASS'Y,LINE ONLY,ABE/S/H/L403bP(PB-I3-FRL)	
	PB-J3-FRL	54621132103	FRAME ASS'Y,LINE ONLY,ABE/S/L603bP~803bP(PB-J3-FRL)	
Single-row	PB-A3-1DB	54621151103	FRAME ASS'Y,ONE ROW, ABE53bP~103bP/S33bP~63bP/H33bP(PB-A3-1DB)	
	PB-C3-1DB	54621152103	FRAME ASS'Y,ONE ROW,ABS103bP/H53bP~103bP(PB-C3-1DB)	
Double-row	PB-A3-2DB	54621151104	FRAME ASS'Y,TWO ROW, ABE53bP~103bP/S33bP~63bP/H33bP(PB-A3-2DB)	
	PB-C3-2DB	54621152104	FRAME ASS'Y,TWO ROW,ABS103bP/H53bP~103bP(PB-C3-2DB)	
Accessory (Plug-in terminal)	PBA-100	62671151120	TERMINAL ASS'Y,PBA100	
	PBA-225	62671153120	TERMINAL ASS'Y,PBA225	

Leading Innovation, Creating Tomorrow 



Safety Instructions

- For your safety, please read user's manual thoroughly before operating.
- Contact the nearest authorized service facility for examination, repair, or adjustment.
- Please contact a qualified service technician when you need maintenance. Do not disassemble or repair by yourself!
- Any maintenance and inspection shall be performed by the personnel having expertise concerned.

LS Industrial Systems Co., Ltd. © 2009.10 LS Industrial Systems Co.,Ltd. All rights reserved.

www.lsis.biz

■ HEAD OFFICE

LS Tower 1026-6, Hogue-dong, Dongan-gu,
Anyang-si, Gyeonggi-do 431-848, Korea

Tel. (82-2)2034-4887, 4873, 4148

Fax. (82-2)2034-4648

■ CHEONG-JU PLANT

Cheong-Ju Plant #1, Song Jung Dong, Hung Duk Ku,
Cheong Ju, 361-720, Korea

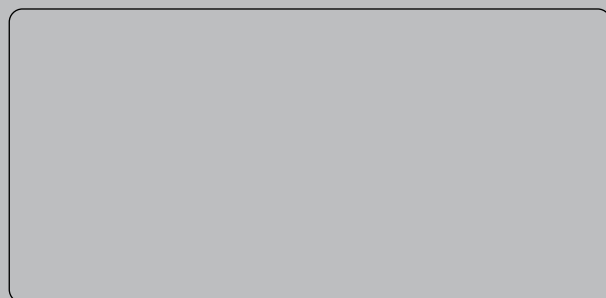

Specifications in this catalog are subject to change without notice due to continuous product development and improvement.

■ Global Network

- **LS Industrial Systems (Middle East) FZE >> Dubai, U.A.E.**
Address: LOB 19 JAFZA VIEW TOWER Room 205, Jebel Ali Freezone P.O. Box 114216, Dubai, United Arab Emirates
Tel: 971-4-886 5360 Fax: 971-4-886-5361 e-mail: hwyim@lsis.biz
- **Dalian LS Industrial Systems Co., Ltd. >> Dalian, China**
Address: No.15, Liaohexi 3-Road, Economic and Technical Development zone, Dalian 116600, China
Tel: 86-411-8273-7777 Fax: 86-411-8730-7560 e-mail: lixk@lsis.com.cn
- **LS Industrial Systems (Wuxi) Co., Ltd. >> Wuxi, China**
Address: 102-A, National High & New Tech Industrial Development Area, Wuxi, Jiangsu, 214028, P.R.China
Tel: 86-510-8534-6666 Fax: 86-510-522-4078 e-mail: xuhg@lsis.com.cn
- **LS-VINA Industrial Systems Co., Ltd. >> Hanoi, Vietnam**
Address: Nguyen Khe - Dong Anh - Ha Noi - Viet Nam
Tel: 84-4-882-0222 Fax: 84-4-882-0220 e-mail: srjo@lsisvina.com
- **LS-VINA Industrial Systems Co., Ltd. >> Hochiminh, Vietnam**
Address: 41 Nguyen Thi Minh Khai Str. Yoco Bldg 4th Floor, Hochiminh City, Vietnam
Tel: 84-8-3822-7941 Fax: 84-8-3822-7942 e-mail: sbpark@lsisvina.com
- **LS Industrial Systems Tokyo Office >> Tokyo, Japan**
Address: 16FL, Higashi-Kan, Akasaka Twin Tower 17-22, 2-chome, Akasaka, Minato-ku Tokyo 107-8470, Japan
Tel: 81-3-3582-9128 Fax: 81-3-3582-2667 e-mail: jschuna@lsis.biz
- **LS Industrial Systems Shanghai Office >> Shanghai, China**
Address: Room E-G, 12th Floor Huamin Empire Plaza, No.726, West Yan'an Road Shanghai 200050, P.R. China
Tel: 86-21-5237-9977 (609) Fax: 89-21-5237-7191 e-mail: jinhk@lsis.com.cn
- **LS Industrial Systems Beijing Office >> Beijing, China**
Address: B-Tower 17FL, Beijing Global Trade Center B/D. No.36, BeiSanHuanDong-Lu, DongCheng-District, Beijing 100013, P.R. China
Tel: 86-10-5825-6025,7 Fax: 86-10-5825-6026 e-mail: cuixiaorong@lsis.com.cn
- **LS Industrial Systems Guangzhou Office >> Guangzhou, China**
Address: Room 1403,14F,New Poly Tower,2 Zhongshan Liu Road,Guangzhou, P.R. China
Tel: 86-20-8326-6764 Fax: 86-20-8326-6287 e-mail: linsz@lsis.biz
- **LS Industrial Systems Chengdu Office >> Chengdu, China**
Address: Room 1701 17Floor, huanminhanjun international Building, No1 Fuxing Road Chengdu, 610041, P.R. China
Tel: 86-28-8670-3101 Fax: 86-28-8670-3203 e-mail: yangcf@lsis.com.cn
- **LS Industrial Systems Qingdao Office >> Qingdao, China**
Address: 7B40,Haixin Guangchang Shenye Building B, No.9, Shandong Road Qingdao 26600, P.R. China
Tel: 86-532-8501-6568 Fax: 86-532-583-3793 e-mail: lirj@lsis.com.cn